

fleur.[®]
ami



PREMIUM PLANTERS & ARTIFICIAL PLANTS · 2024

BABYLON - 3D printed in Germany with recycled wood

2024

WELCOME *Willkommen*



The new, exclusive models of the **Babylon**, **Big Bag** and **Organic** series are 3D printed. Unique in design, printed in Germany and made from sustainable raw materials. Our designer Peter tells the **story** behind these creative product concepts on the following pages 4/5.

Welcome to the year 2024 and therefore also to this new annual catalog, in which we would like to show you not only over 250 new products, but also design suggestions and inspiration.

Each of the **244 pages**, every product and every idea contains the essence of what drives us: our passion for **premium planters & artificial plants**. High-quality, unique and simply amazing!

Our focus in 2024 is on serving our **retail partners** quickly and reliably **with good availability**, achieving a lot together. **Thank you for your loyalty!**

But now have fun discovering!

Your fleur ami Team

*3D gedruckt sind die neuen, exklusiven Modelle der Serie **Babylon**, **Big Bag** und **Organic**. Einzigartig im Design, in Deutschland gedruckt und aus nachhaltigen Rohstoffen hergestellt. Die jeweilige **Story** zur kreativen Produkt-Idee erzählt unser **Designer Peter** auf den Folge-Seiten 4/5.*

Willkommen im Jahr 2024 und damit auch in diesem neuen Jahreskatalog, in dem wir Euch nicht nur über 250 neue Produkte, sondern auch Gestaltungsvorschläge, und Inspirationen zeigen möchten.

In jeder der **244 Seiten**, jedem Produkt, in jeder Idee steckt die Essenz dessen, was uns antreibt: die Leidenschaft für „**premium planters & artificial plants**“. Hochwertig, einzigartig und einfach amazing!

Unser Fokus liegt 2024 darauf, unsere **Handelspartner** mit guten **Verfügbarkeiten schnell und zuverlässig** zu bedienen und gemeinsam viel zu bewegen. **Danke für Eure Treue!**

Jetzt aber viel Spaß beim Entdecken!

Euer fleur ami Team

PREMIUM
PLANTERS
&
ARTIFICIAL
PLANTS

THE BABYLON - STORY

The famous **hanging gardens of Babylon** - or what one imagines them to be - as a functional source of inspiration and succulents as a formal source of inspiration combine to create a three-part planter that invites you to arrange different (artificial) plants.

Like three pots on an etagere, only united in one product. Babylon opens up **countless possibilities** for combining grasses with hanging plants, tropical arrangements or simply different herbs.

Manufactured using the **3D printing** process, the series has a number of advantages: there is virtually no production waste and only **recycled plastic** is used (sometimes even mixed with **wood fibres**). This means that the Babylon series is all about **sustainability**.

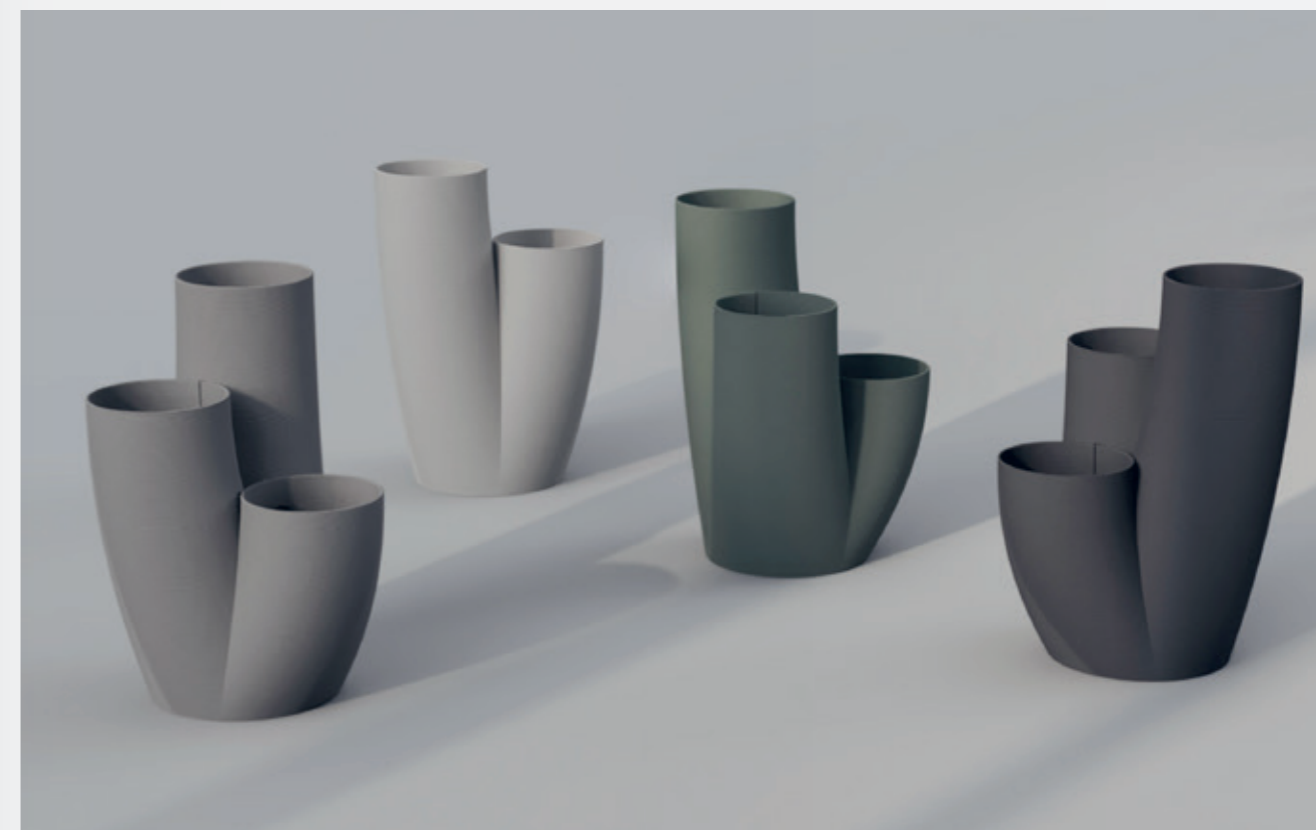

Die berühmten **hängenden Gärten von Babylon** - bzw. das, was man sich darunter vorstellt - als funktionale und Sukkulente als formale Inspirationsquelle, ergeben in Kombination ein dreigeteiltes Pflanzgefäß, das zum Arrangieren verschiedener (Kunst-) Pflanzen einlädt.

Wie drei Töpfe auf einer Etageren, nur in einem Produkt vereint; Babylon eröffnet **unzählige Möglichkeiten** zur Kombination von Gräsern mit hängenden Pflanzen, tropischen Arrangements oder einfach verschiedenen Kräutern.

Im **3D-Druck-Verfahren** hergestellt, ergeben sich für die Serie einige Vorteile: es entsteht nahezu kein Produktionsabfall und es wird ausschließlich **recycelter Kunststoff** (teilweise sogar noch **mit Holzfasern** versetzt) eingesetzt. So steht die Serie Babylon ganz im Zeichen der **Nachhaltigkeit**.



„Design in the spirit of sustainability -
3D printed in Germany!
A project, that immediately inspired me”

„Design im Zeichen der Nachhaltigkeit - 3D gedruckt in Deutschland!
Ein Projekt, das mich sofort begeistert hat”

- Peter Vosding, Industrial Design



„With our modern high rack warehouse and our motivated team we strive for the fastest delivery every day.”

Marc Vukas –
warehouse manager /
Lagerleiter

Mit unserem modernen Hochregallager und unserem motivierten Team bemühen wir uns täglich um schnellste Lieferung.



Alphabetical index

Accessories / Zubehör.....236	Coral.....156	Lemon Fushion46	Rocks / Dekosteine.....237
Artic Stone160	Corten Steel112	Linea182	Rocky.....154
Artificial Plants /	Corum.....186	Loft.....102	Royal.....136
Kunstpflanzen204	Croc.....152	Lunea114	Service Car.....240
Atlantis162	Curved River90	Lush Botanic42	Shell.....168
Aurum gold120	Division Lite.....76	Magnifico.....166	Stage.....190
Babylon 3D12	Fertilisier / Dünger HM 10 ...238	Nomad Lion38	Stripe86
Banana.....72	Flora180	Organic 3D16	Styrofoam Discs /
Big Bag 3D14	Ghostwood / Manzanita234	Pandora Gold Leaf.....122	Styroporscheiben.....236
Blooming Namaste44	Grace.....110	Pandora Oxidized.....126	Talon132
Cigar.....128	Grand150	Pandora Silver Leaf.....124	Turquesa118
Cigar Oxidized.....130	Graphit180	Petal182	Welcome.....10
Clay / Ton.....237	Gravita116	Polystone.....20	Woody64
Cliff.....184	Gritto180	Pottery180	
Cobalt Jungle40	Inliner / Pflanzeinsätze232	Premium.....192	
Coconut56	Lava.....164	River.....96	
Conical.....188	Leaf Shine / Blattglanz.....239	Roccastone48	



„Discover the latest collection in our showroom over a good cup of coffee.
www.fleur-ami.com/showroom
Make a personal appointment!

Entdecke die neuesten Kollektionen in unserem Showroom bei einer guten Tasse Kaffee.
www.fleur-ami.com/showroom
Jetzt persönlichen Termin vereinbaren!

Important Notice / Wichtiger Hinweis

PRICES: All prices shown are recommended retail prices excluding VAT (RRP net excluding VAT)

ONLINE-DEAL: These exclusive offers have a lower RRP than usual. Retailers have the option of ordering online deals at special conditions.

OUTDOOR USE OF WATERPROOF PLANTERS: Most of our planters are waterproof as a standard to use them indoors. For outdoor use make sure to drill a hole for drainage.

PREISE: Alle Preise sind unverbindliche Preise in Euro, zzgl. gesetzlicher Mehrwertsteuer (UVP netto)

ONLINE-DEAL: Diese exklusiven Angebote haben einen geringeren UVP als gewöhnlich. Händler haben die Möglichkeit, Online-Deals zu gesonderten Konditionen zu bestellen.

AUSSENEINSATZ WASSERDICHTER GEFÄSSE: Die meisten unserer Pflanzgefäße sind standardmäßig wasserdicht für die Verwendung im Innenbereich. Für die Verwendung im Außenbereich und zum Wasserablauf ist daher ein Drainage-Loch zu bohren.



Caption / Legende

Outdoor use possible Außeneinsatz möglich	Lightweight besonders leicht	UV-resistant UV-stabil	Items per packaging unit Artikel je Verpackungseinheit
Semi-Outdoor Außeneinsatz bedingt möglich	Waterproof Wasserdicht	Handmade Handgemacht	Items per pallet Artikel pro Palette
indoor use only Nur für Innenräume	Frost resistant Frostfest	Number of leaves Anzahl der Blätter	

The whole world of planters and vases.
Die ganze Welt der Pflanzkübel und Pflanzgefäße.

Artificial plants in all their magnificence.
Kunstpflanzen in ihrer ganzen Pracht.

Extensive and helpful accessories
Umfangreiches und hilfreiches Zubehör

All new products at a glance.
Alle Neuheiten auf einen Blick.

Magazine - Trends, tips and inspiration.
Magazin - Trends, Tipps und Inspiration

B2B dealers with your individual conditions.
Händler B2B Bereich mit ihren individuellen Konditionen.

Detailed product photos
Aussagekräftige Produktabbildungen.

Detailed product information, specs and article number.
Detaillierte Produktbeschreibung, mit Maßen und Artikelnummer.

NEW: All availability and deliveries at a glance.
Alle Verfügbarkeiten und Lieferungen auf einen Blick

NEW: 8 filter options - find your product based on colours, shapes, dimensions and much more.
8 Filtermöglichkeiten - finden Sie Ihr Produkt zum Beispiel anhand von Farben, Formen, Maßen und vielen mehr

**BECOME A DEALER!
REGISTER NOW!**

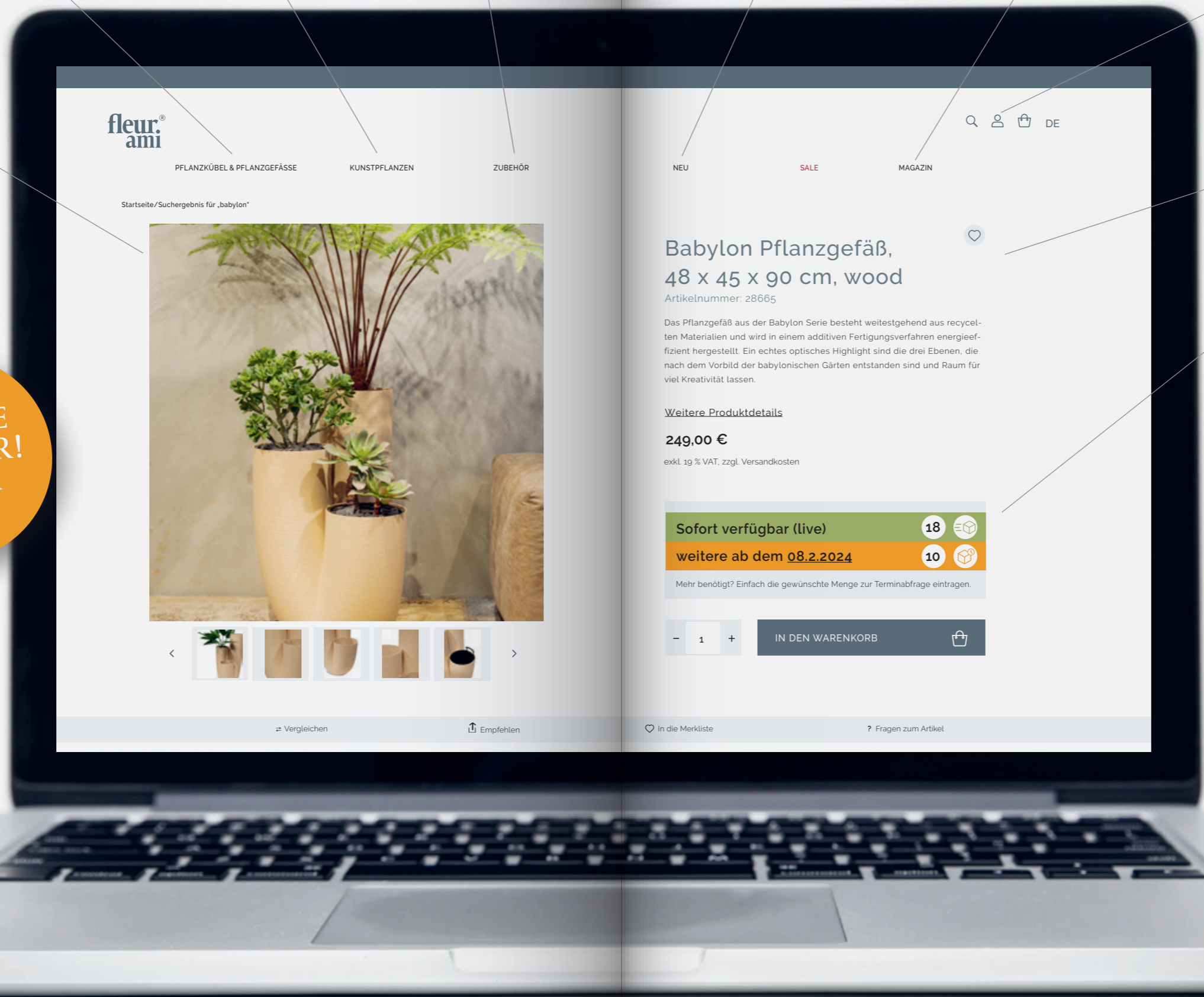



Welcoming culture.

Willkommenskultur.

The WELCOME plant planter is particularly hospitable. The word „Welcome“ in embossed letters out of the body of the Polystone plant pot in 23 languages: German, English, Dutch, French, Greek, Italian, Portuguese, Russian, Spanish, Chinese (Mandarin), Swedish, Norwegian, Danish, Finnish, Slovak, Czech, Polish, Croatian, Slovenian, Tagalog, Japanese, Arabic, Turkish.



Passgenauer PFLANZEINSÄTZE

INLINER			
A	22985	LECHUZA Liner	25,10 net.
B	20021	LECHUZA Liner	26,50 net.



WELCOME FLOOR PLANTERS / BODENVASE

Ø	Ø	□	□	kg	natural	Sales price excl VAT UVP zzgl. MwSt.
39	22	90	85	10	A 23020	295.-
52	30	120	115	22,3	B 23019	549.-

WELCOME IN 2024



WELCOME #23020



NEW!
NEU!



JADEBAUM
CRASSULA OVATA
#23835
on page · auf Seite 225

GOLDFRUCHTPALME -
ARECA PALM
#28428
on page · auf Seite 209



SUKKULENTE
AUF STAMM
#23582
on page · auf Seite 227

BABYLON 3D

A



MATCHING INSERTS NOT INCLUDED!
PASSENDE EINSÄTZE NICHT INKLUSIVE!

INLINER			
A	22985	LECHUZA Liner	25,10 net.
B	20021	LECHUZA Liner	26,50 net.



ONLINE
DEAL

SUSTAINABLE PRODUCT!
Made with recycled material,
model wood made within 40% Wood fibers.

NACHHALTIGES PRODUKT!
Aus recyceltem Rohstoff,
zum mit 40% Holzfasern.



BABYLON FLOOR PLANTERS / BODENGEFÄSSE

Ø	Ø	□	□	kg	wood	midnight black	moonlight grey	stone grey	sales price excl. VAT UVP zzgl. MwSt.	INLINER
48	22	90	25	4,7	A 28665	D 28664	G 28662	J 28663	498,-	22985
64	30	110	32	8,0	B 28661	E 28660	H 28658	K 28659	749,-	20021



13



SUSTAINABLE PRODUCT!
Made with recycled material,
model wood made within 40% Wood fibers.

NACHHALTIGES PRODUKT!
Aus recyceltem Rohstoff, zum mit 40% Holzfasern.

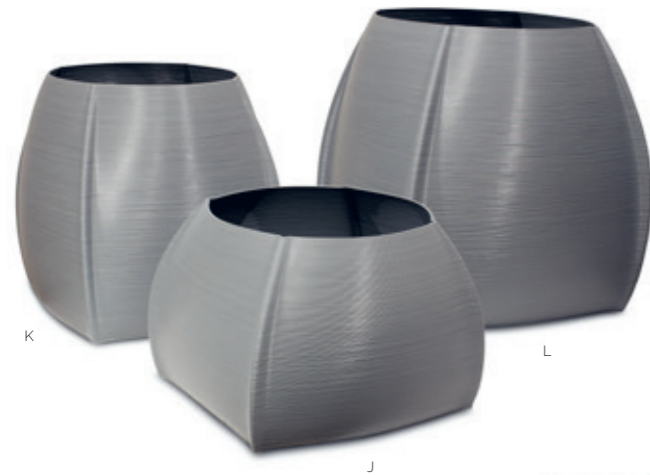

BIG BAG FLOOR PLANTERS / BODENGEFÄSSE

□	∅	□	□	kg	wood	midnight black	moonlight grey	stone grey	sales price excl. VAT UVP zzgl. MwSt.	INLINER
42x42	35	31	30.5	2.6	A 28657	D 28656	G 28654	J 28655	209,-	18612
42x42	35	46	45	4.0	B 28653	E 28652	H 28650	K 28651	335,-	18604
55x55	45	58	57	6.2	C 28649	F 28648	I 28646	L 28647	498,-	18607

NEW!
NEU!

Big Bag 3D

GELDBAUM
CRASSULA OVATA
#20292
on page · auf Seite 219

ALOCASIA CALIDORA -
ELEFANTENOHHR
#23578
on page · auf Seite 220





NEW!
NEU!

ALOCASIA -
ELEFANTENOHHR
#23839
on page · auf Seite 221

ORGANIC 3D



SUSTAINABLE PRODUCT!
Made with recycled material,
model wood made within 40% Wood fibers.

NACHHALTIGES PRODUKT!
Aus recyceltem Rohstoff, zum mit 40% Holzfasern.

MATCHING INSERTS NOT INCLUDED!
PASSENDE EINSÄTZE NICHT INKLUSIVE!

INLINER			
A	22985	LECHUZA Liner	25,10 net.
B	20021	LECHUZA Liner	26,50 net.



ONLINE
DEAL



ORGANIC 3D FLOOR VASE / BODENVASEN

Ø	Ø	□	□	kg	wood	midnight black	moonlight grey	stone grey	sales price excl. VAT UVP zzgl. MwSt.
27	22	35	34	1.3	A 28669	D 28668	G 28666	J 28667	168,-
35	30	75	74	3.4	B 28681	E 28680	H 28678	K 28679	328,-
35	30	96.5	95.5	4.4	C 28685	F 28684	I 28682	L 28683	429,-



KIRSCHBLÜTENBAUM
#23580
on page - auf Seite 229

NEW!
NEU!

ORGANIC 3D

K

J

ONLINE
DEAL

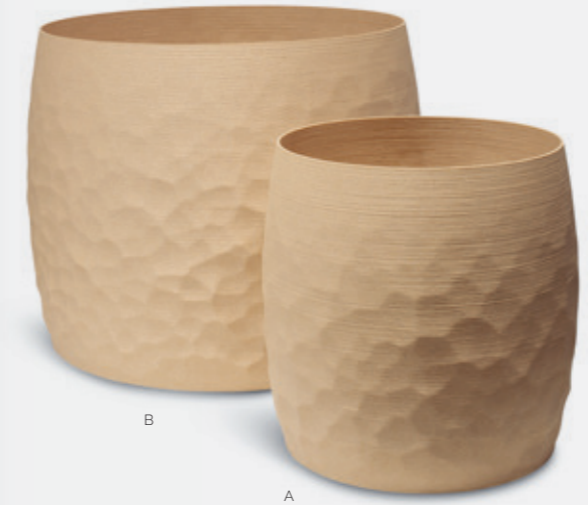

B

A



E

D



H

G

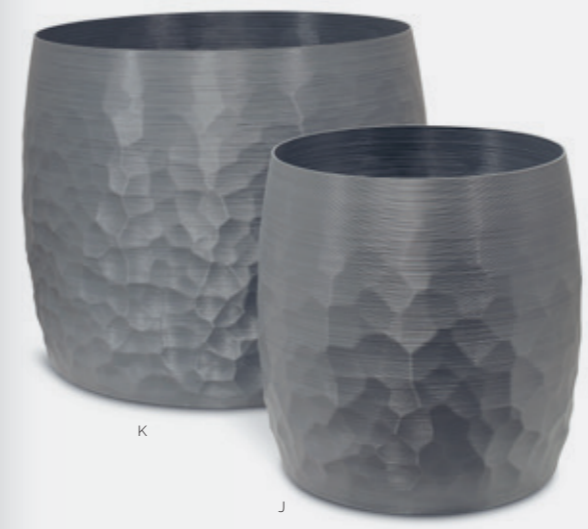

K

J

SUSTAINABLE PRODUCT!
Made with recycled material,
model wood made within 40% Wood fibers.

NACHHALTIGES PRODUKT!
Aus recyceltem Rohstoff, zum mit 40% Holzfasern.



ORGANIC 3D FLOOR PLANTERS / BODENGEFÄSSE

Ø	Ø	□	□	kg	wood	midnight black	moonlight grey	stone grey	sales price excl. VAT	INLINER
									UVP zzgl. MwSt.	
44	40	45	44	2.8	A 28673	D 28672	G 28670	J 28671	328,-	18604
70	64	57	56	6.6	B 28677	E 28676	H 28674	K 28675	587,-	18609



CUBE



POLYSTONE PLANT CUBE / PFLANZWÜRFEL

□	▣	□	▣	kg	grey			creme			anthracite			Sales price excl. VAT			
					A	B	C	D	E	F	G	H	J	K	L	M	UVP zzgl. MwSt.
30 x 30	24	30	29	3.5	A	17217				E	17216			J	18041	109,-	18611
40 x 40	34	40	38	7	B	17219				F	17218			K	18042	175,-	18612
50 x 50	44	50	48	10	C	17221				G	17220			L	18043	259,-	18613
60 x 60	54	60	59	15	D	17223				H	17222			M	18044	385,-	18608







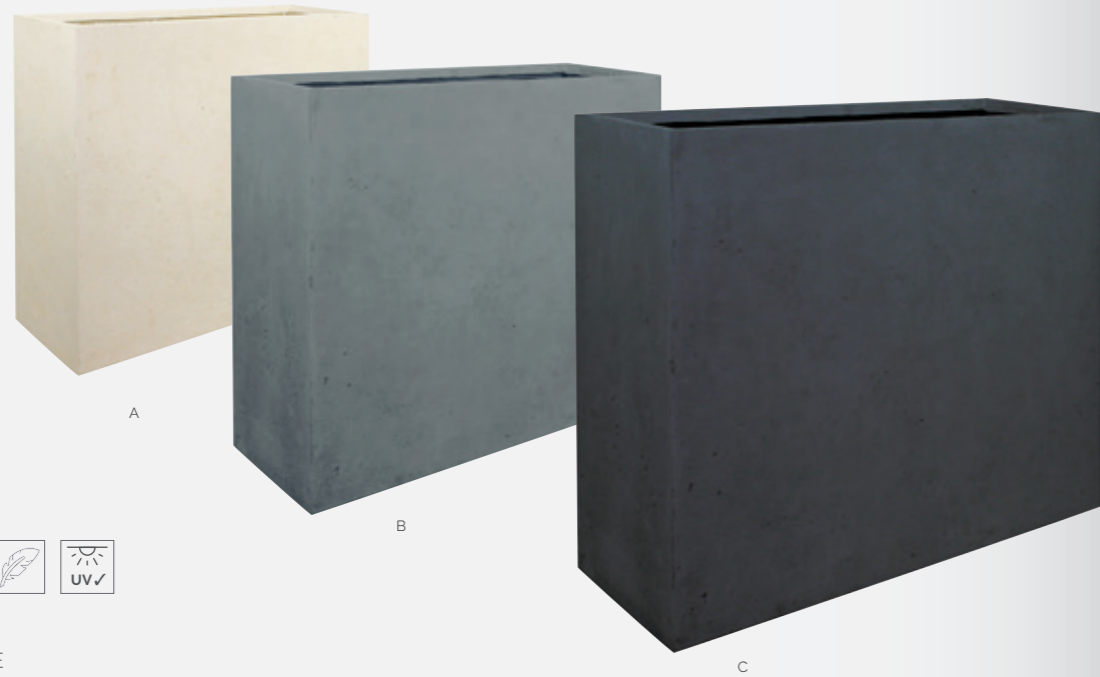

Defining areas. Bereiche definieren.



POLYSTONE DIVIDE

					kg	creme	grey	anthracite	Sales price excl VAT UVP zzgl. MwSt.
100 x 35	94 x 30	80	78	25.5	A	17246	B	18056	498,-
100 x 35	94 x 30	60	58	21.0	-	28686	-	28687	398,-

**NEW!
NEU!**



DIVIDE





For every purpose.

Für jede Anwendung.



B

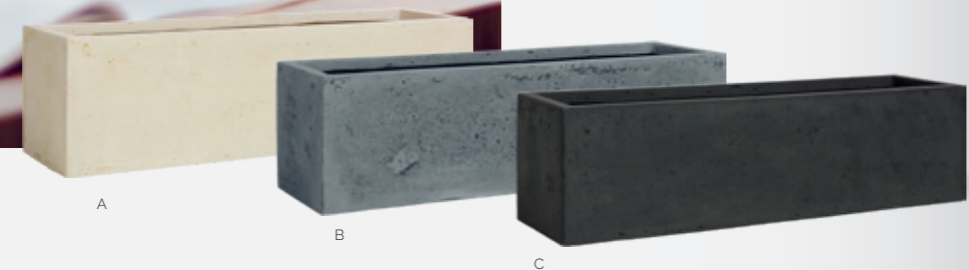

A

B

C

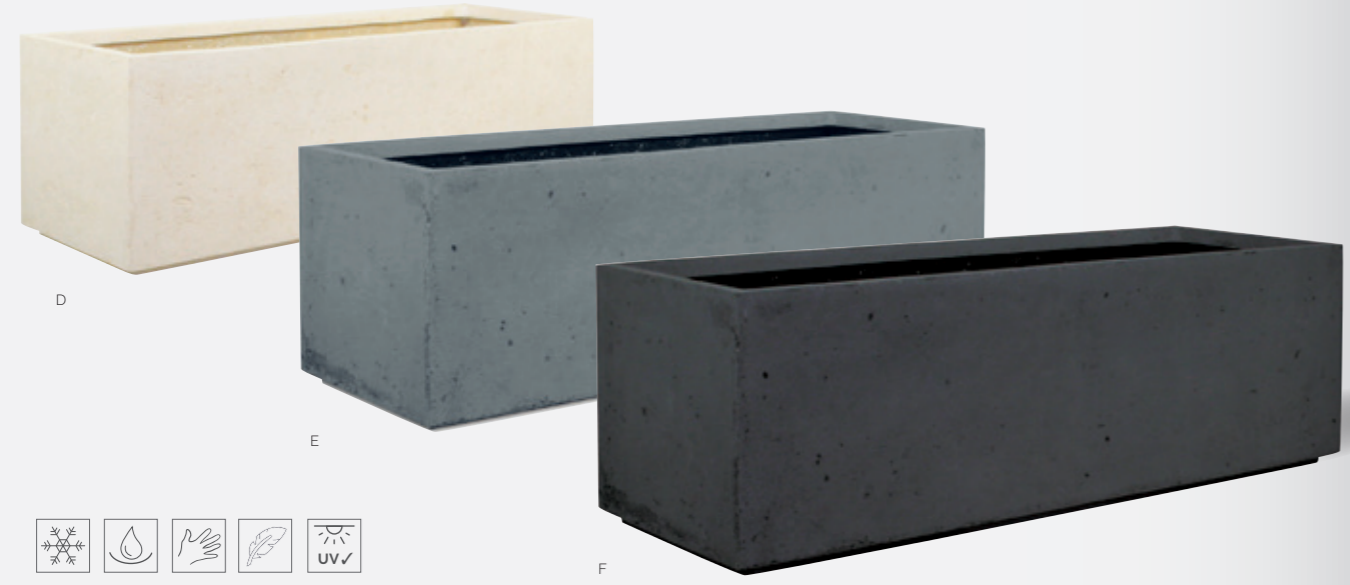

D

E

F



POLYSTONE PLANTER BOX / PFLANZKASTEN

				kg	Sales price excl. VAT						
☐	☐	☐	☐		UVP zzgl. MwSt.						
65 x 18	61 x 14	18	16	3,5	A	18596	B	18597	C	18598	98,-
100 x 35	92 x 28	30	28	12,5	D	17248	E	17249	F	18057	225,-



E

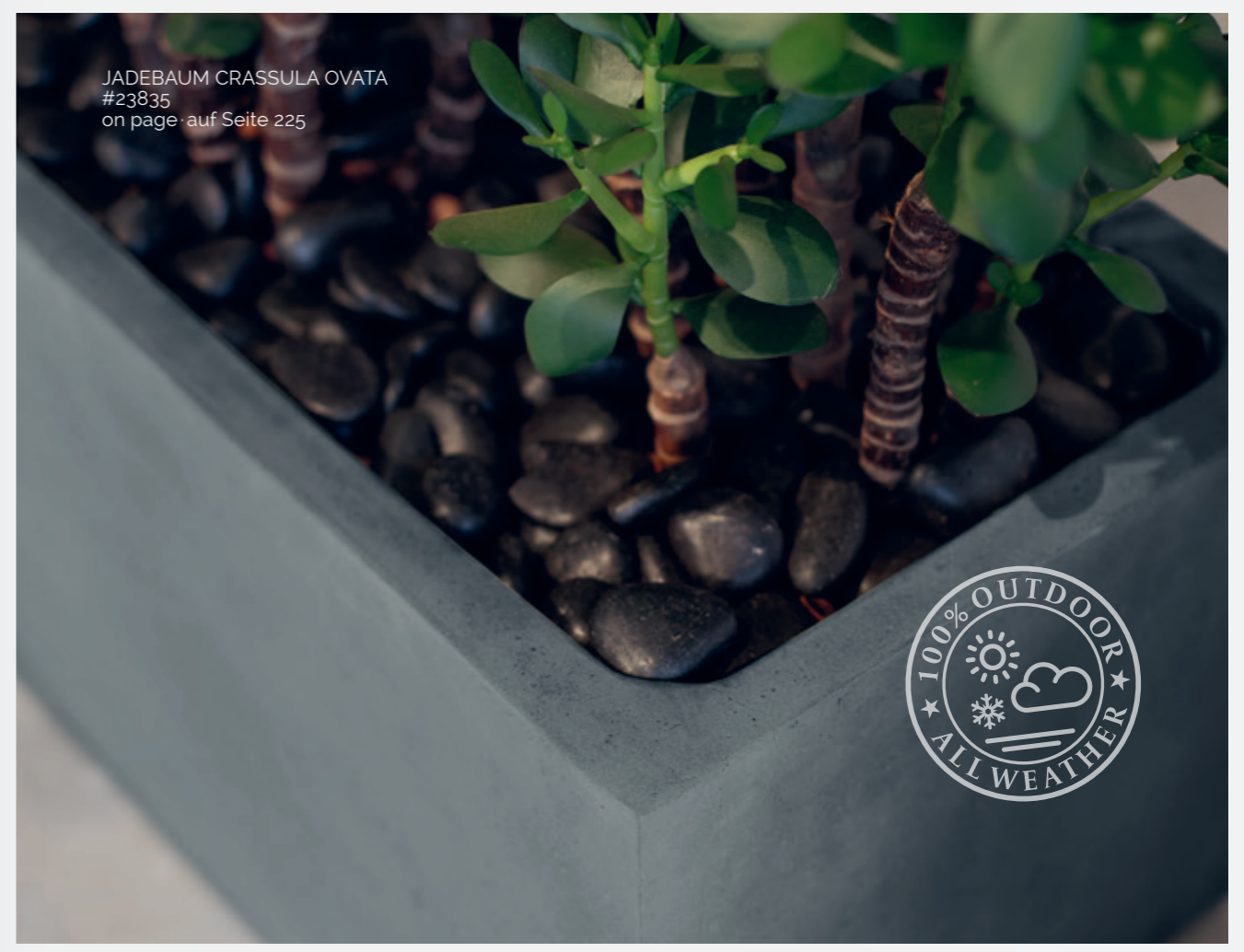

JADEBAUM CRASSULA OVATA #23835 on page auf Seite 225





SARACENA GREEN
KOBRALILIE GRÜN
#23587
on page · auf Seite 227

TOWER

H



Columns. Säulen.



POLYSTONE PLANT COLUMN / PFLANZSÄULE

□	▣	□	▣	kg	creme	grey	anthracite	Sales price excl. VAT UVP zzgl. MwSt.	INLINER
35 x 35	26	70	63	11,5	G 23013	J 23014	M 23015	235.-	18611
35 x 35	26	100	92	11,9	H 23042	K 23043	N 23044	298.-	18611
40 x 40	26	120	113	20	I 23045	L 23046	O 23047	385.-	18612

LID / DECKEL

□	▣	□	▣	kg	creme	grey	anthracite	
35 x 35	-	3	-	2	23016	23017	23018	45.-
40 x 40	-	4	-	2,5	17210	17211	18038	49.-



GLOBE



C

B



NEW!
NEU!

A

B

C

NEW!
NEU!

D

E

F

Allrounder. Runde Sache.

NEW!
NEU!

G

H

I



POLYSTONE GLOBE

Ø	Ø	□	▣	kg	Sales price excl. VAT			INLINER	
					creme	grey	anthracite		UVP zzgl. MwSt.
40	25	28,5	27	33,5	A 28406	D 28407	G 28405	129,-	17896
60	36	43	38	8,75	B 21030	E 21029	H 21031	249,-	18605
80	50	57	54	15,5	C 21033	F 21032	I 21034	439,-	18609



MATCHING INSERTS NOT INCLUDED!
PASSENDE EINSÄTZE NICHT INKLUSIVE!

INLINER

A+D	22985	LECHUZA Liner	25,10 net.
B+C	20021	LECHUZA Liner	26,50 net.



Timeless beauty.
Zeitlos schön.



ESSENCE FLOOR PLANTERS / BODENVASE

Ø	Ø	□	□	kg	natural		grey		Sales price excl. VAT UVP zzgl. MwSt.
					A	B	C	D	
39	22	90	88	9,0	A	23007	C	23008	219,-
52	30	120	118	18,5	B	23010	D	23011	449,-





Classic anthracite.

Klassisch anthrazit.



MATCHING INSERTS NOT INCLUDED!
PASSENDE EINSÄTZE NICHT INKLUSIVE!

INLINER

A	22985	LECHUZA Liner	25,10 net.
B	20021	LECHUZA Liner	26,50 net.

B

A



ESSENCE FLOOR VASE / BODENVASEN

Ø	Ø	□	□	kg	anthracite	sales price excl. VAT UVP zzgl. MwSt.
39	22	90	88	9,0	A 23009	219,-
52	30	120	118	18,5	B 23012	449,-



B



Modern classics.

Moderne Klassiker.

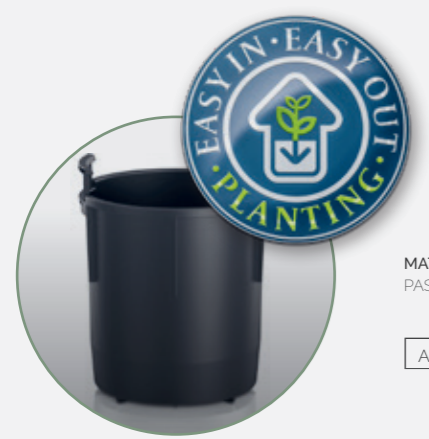

MATCHING INSERTS NOT INCLUDED!
PASSENDE EINSÄTZE NICHT INKLUSIVE!

INLINER
A-I 20021 LECHUZA Liner 26,50 net.



POLYSTONE CONICAL FLOOR VASE / BODENVASE

Ø	Ø	□	□	creme	grey	anthracite	Sales price excl. VAT UVP zzgl. MwSt.
43	30	80	72	A 21018	D 21017	G 21019	255,-
46	30	95	87	B 21021	E 21020	H 21022	305,-
48	30	110	102	C 21024	F 21023	I 21025	369,-



Brings style to the table.
Tischgerecht.



POLYSTONE EGO PLUS BOWL / PFLANZSCHALE

Ø	Ø	□	□	kg	creme	grey	anthracite	Sales price excl. VAT UVP zzgl. MwSt.
40	33	18	17	2,5	A 17238	E 17239	I 18052	75,-
50	42	22	21	4	B 17240	F 17241	J 18053	125,-
70	60	32	30	9	C 17242	G 17243	K 18054	245,-





EGO GIANT



F



Natural colours.
Naturtöne.



POLYSTONE EGO GIANT FLOOR PLANTER / BODENGEFÄSS



Ø	Ø	□	□	kg	Sales price excl. VAT			INLINER	
					creme	grey	anthracite		
70	60	60	58	15.5	A 17968	C 17966	E 18064	375.-	18609
80	71	70	67	19.5	B 17969	D 17967	F 18065	559.-	18610

NOMAD LION



PARADIESVOGELBLUME - STRELITZIE
#28430
on page · auf Seite 205



NOMAD LION PLANTERS / PFLANZGEFÄSSE

Ø	Ø	□	□	kg	multicolor	sales price excl. VAT	
						UVP zzgl. MwSt.	INLINER
30	19.7	43	42.7	2.3	D	28549	105,- 19799
47	30.7	62	61.7	5.5	E	28548	198,- 18614
zer Set NOMAD LION					D-E	28547	275,- BEST-PRICE %

ENAMELED ALUMINIUM
EMAILLIERTES ALUMINIUM



NOMAD LION TABLE TOP VASE / TISCHGEFÄSS

Ø	Ø	□	□	kg	multicolor	sales price excl. VAT	
						UVP zzgl. MwSt.	INLINER
23	21.6	22	21.6	0.9	A	28553	35,- 17895
27	25.2	25.5	25.2	1.2	B	28552	45,- 19799
33	29.4	29	28.7	1.5	C	28551	55,- 17896
3er Set NOMAD LION					A-C	28550	125,- BEST-PRICE %

NEW!
NEU!



FENSTERBLATT - MONSTERA
#28448
on page · auf Seite 206

COBALT JUNGLE

DATTELPALME -
PHOENIX PALM
#28426
on page - auf Seite 208

**NEW!
NEU!**



E

D



C



E

D

COBALT JUNGLE PLANTERS / PFLANZGEFÄSSE

Ø	Ø	□	□	kg	multicolor	sales price excl VAT	
						UVP zzgl. MwSt.	INLINER
30	19.7	43	42.7	2.3	D	28563	105,- 19799
47	30.7	62	61.7	5.5	E	28562	198,- 18614
2er Set COBALT JUNGLE					D-E	28561	275,- BEST-PRICE % -

ENAMELED ALUMINIUM
EMAILLIERTES ALUMINIUM



C

B

A



COBALT JUNGLE TABLE TOP VASE / TISCHGEFÄSS

Ø	Ø	□	□	kg	multicolor	sales price excl VAT	
						UVP zzgl. MwSt.	INLINER
23	21.6	22	21.6	0.9	A	28567	35,- 17895
27	25.2	25.5	25.2	1.2	B	28566	45,- 19799
33	29.4	29	28.7	1.5	C	28565	55,- 17896
3er Set COBALT JUNGLE					A-C	28564	125,- BEST-PRICE % -

NEW!
NEU!

ALOCASIA -
ELEFANTENOHR
#28429
on page · auf Seite 220



B

LUSH BOTANIC



B

A



DATTELPALME -
PHOENIX PALM
#28426
on page · auf Seite 208

B

LUSH BOTANIC PLANTERS / PFLANZGEFÄSSE

Ø	Ø	□	□	kg	multicolor	sales price excl. VAT UVP zzgl. MwSt.	INLINER
30	19,7	43	42,7	2,3	A	28577 105,-	19799
47	30,7	62	61,7	5,5	B	28576 198,-	18614
3er Set LUSH BOTANIC					A-B	28575 275,-	BEST-PRICE %



FENSTERBLATT -
MONSTERA
#28448
on page · auf Seite 207

ENAMELED ALUMINIUM
EMAILLIERTES ALUMINIUM



E

C

D

LUSH BOTANIC TABLE TOP VASE / TISCHGEFÄSSE

Ø	Ø	□	□	kg	multicolor	sales price excl. VAT UVP zzgl. MwSt.	INLINER
23	21,6	22	21,6	0,9	C	28581 35,-	17895
27	25,2	25,5	25,2	1,2	D	28580 45,-	19799
33	29,4	29	28,7	1,5	E	28579 55,-	17896
3er Set LUSH BOTANIC					C-E	28578 125,-	BEST-PRICE %

NEW!
NEU!



JADEBAUM
CRASSULA OVATA
#28441
on page - auf Seite 225

D

BLOOMING NAMASTE



BLOOMING NAMASTE PLANTERS / PFLANZGEFÄSSE

Ø	Ø	□	▣	kg	multicolor	sales price excl. VAT	
						UVP zzgl. MwSt.	INLINER
30	19.7	43	42.7	2.3	A	28570	105,- 19799
47	30.7	62	61.7	5.5	B	28569	198,- 18614
3er Set BLOOMING NAMASTE						A-B	275,- BEST PRICE %



ENAMELED ALUMINIUM
EMAILLIERTES ALUMINIUM



BLOOMING NAMASTE TABLE TOP VASE / TISCHGEFÄSS

Ø	Ø	□	▣	kg	multicolor	sales price excl. VAT	
						UVP zzgl. MwSt.	INLINER
23	21.6	22	21.6	0.9	C	28574	35,- 17895
27	25.2	25.5	25.2	1.2	D	28573	45,- 19799
33	29.4	29	28.7	1.5	E	28572	55,- 17896
3er Set BLOOMING NAMASTE						C-E	125,- BEST PRICE %

LEMON FUSION



LEMON FUSIONPLANTERS / PFLANZGEFÄSSE

Ø	Ø	□	□	kg	multicolor	sales price excl. VAT	
						UVP zzgl. MwSt.	INLINER
30	19.7	43	42.7	2.3	D	28556	105,- 19799
47	30.7	62	61.7	5.5	E	28555	198,- 18614
2er Set LEMON FUSION						D-E	275,- BEST-PRICE % -



ENAMELED ALUMINIUM
EMAILLIERTES ALUMINIUM



LEMON FUSION TABLE TOP VASE / TISCHGEFÄSS

Ø	Ø	□	□	kg	multicolor	sales price excl. VAT	
						UVP zzgl. MwSt.	INLINER
23	21.6	22	21.6	0.9	A	28560	35,- 17895
27	25.2	25.5	25.2	1.2	B	28559	45,- 19799
33	29.4	29	28.7	1.5	C	28558	55,- 17896
3er Set LEMON FUSION						A-C	125,- BEST-PRICE % -

NEW!
NEU!



ROCCASTONE

NEW!
NEU!

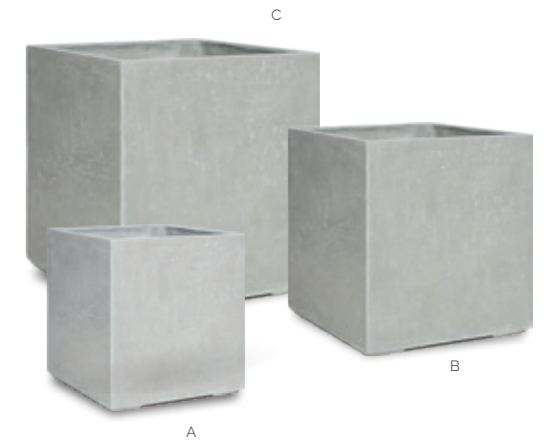

CONCRETE
BETON



#	Sales price excl. VAT UVP zzgl. MwSt.
28744	9,-



ROCCASTONE CUBE / PFLANZWÜRFEL

□	■	□	■	natur beton	anthracite	Sales price excl. VAT UVP zzgl. MwSt.	Optional feet/castors Optionale Stellfüße/Rollen
40 x 40	34 x 34	44	40	A 28498	F 28512	145,-	-
50 x 50	44 x 44	54	50	B 28499	G 28513	189,-	-
60 x 60	54 x 54	64	60	C 28500	H 28514	269,-	-
80 x 80	72 x 72	60	56	D 28501	I 28515	459,-	4 pieces / Stück
100 x 100	92 x 92	60	56	E 28502	J 28516	598,-	4 pieces / Stück



4x
optional

Easier planting thanks to the intermediate floor
Einfachere Bepflanzung dank Zwischenboden

NEW!
NEU!



CONCRETE
BETON

4x
optional

Easier planting thanks to the intermediate floor
Einfachere Bepflanzung dank Zwischenboden



#28744
Swivel castors, each for Gelenkrollen, je Stück

ROCCASTONE ROOM DIVIDERS / RAUMTEILER				Sales price excl. VAT UVP zzgl. MwSt.		Optional castors Optionale Rollen		Sales price excl. VAT UVP zzgl. MwSt.	
□	▣	□	▣	natur beton	anthracite	#	#		
100 x 35	95 x 30	60	56	A 28503	C 28517	295,-	4 pieces / Stück	28744	9,-
100 x 35	95 x 30	80	74	B 28504	D 28518	345,-	4 pieces / Stück	28744	9,-

RAUMTEILER

ROCCASTONE

Thanks to its optional hidden casters fleur ami® room dividers are easy maneuverable.

Dank der optionalen verdeckten Rollen sind die fleur ami® Raumteiler leicht zu manövrieren.



NEW!
NEU!



TOWER

SÄULEN



CONCRETE
BETON

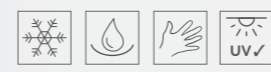

ROCCASTONE COLUMN PLANTERS / PFLANZSÄULEN

				natur beton	anthracite	Sales price excl. VAT UVP zzgl. MwSt.	INLINER
□	▣	□	▣	A	C	205,-	17897
35 x 35	30 x 30	80	40	28505	28519		
35 x 35	30 x 30	100	40	B	D	245,-	17897
				28506	28520		

NEW!
NEU!



Straight or curved!
Gerade oder gerundet.

CONCRETE
BETON



ROCCASTONE FLOOR PLANTER / BODENGEFÄSS CYLINDER

Ø	Ø	□	□	natur beton	anthracite	Sales price excl. VAT UVP zzgl. MwSt.	INLINER	#	Sales price excl. VAT UVP zzgl. MwSt.
48	42	30	26	A	28509	145,-	18604	-	-
60	52	40	36	B	28510	235,-	18606	28744	9,-

ROCCASTONE FLOOR PLANTER / BODENGEFÄSS CLASSIC

Ø	Ø	□	□	natur beton	anthracite	Sales price excl. VAT UVP zzgl. MwSt.	INLINER
45	37	38	34	E	28507	135,-	18603
55	47	46	42	F	28508	198,-	18605



ONLINE
DEAL

NEW!
NEU!



B



A

Made from COCO SHELLS

SUSTAINABLE PRODUCT!
Upcycled coconut shell material.

NACHHALTIGES PRODUKT!
Ucyclet mit Kokosnuss-Schalen.



COCONUT FLOOR VASE / BODENVASEN

Ø	Ø	□	□	kg		Sales price excl. VAT		
						UVP zzgl. MwSt.	INLINER	
39	33	75	31	10,8	A	28473	319.-	18603
46.5	42	90	32	16,3	B	28474	399.-	18605



COCONUT



ECO LOVE

NEW!
NEU!



B



A

ONLINE
DEAL

SUSTAINABLE PRODUCT!
Upcycled coconut shell material.

NACHHALTIGES PRODUKT!
Ucyclet mit Kokosnuss-Schalen.



COCONUT FLOOR PLANTERS / BODENGEFÄSSE

Ø	Ø	□	□	kg		Sales price excl VAT	INLINER
						UVP zzgl. MwSt.	
45	38.5	50	46	10.4	A	28478	229.- 18604
60	53.5	65	61	17.2	B	28479	439.- 18607





NEW!
NEU!



NATURAL BEAUTY

SUSTAINABLE PRODUCT!
Upcycled coconut shell material.

NACHHALTIGES PRODUKT!
Ucyclet mit Kokosnuss-Schalen.



A



B



COCONUT PLANTERS / PFLANZGEFÄSSE GLOBE

Ø	Ø	□	□	kg		Sales price excl VAT	INLINER
						UVP zzgl. MwSt.	
50	28	40	39	8,15	A	28475	205,- 18604
70	34	56	55	13,5	B	28476	319,- 18607



NEW!
NEU!



HAND CRAFTED

SUSTAINABLE PRODUCT!
Upcycled coconut shell material.

NACHHALTIGES PRODUKT!
Ucyclet mit Kokosnuss-Schalen.



B



A

ONLINE
DEAL



COCONUT PFLANZGEFÄSSE

Product	∅	∅	□	▣	kg		Sales price excl. VAT UVP zzgl. MwSt.
COCONUT planters / Tischgefäß	76x26,5	70x23	26,5	24	6	A	28480 239,-
COCONUT planters / Pflanzschale	43	37	22	20	4,2	B	28477 165,-



A



WOODEN BEAUTY



NEW!
NEU!

B



B



A



SUSTAINABLE PRODUCT!
Recycled Teak wood.

NACHHALTIGES PRODUKT!
Recyceltes Teak-Holz.



WOODY FLOOR VASE / BODENVASE

Ø	Ø	□	□	kg		sales price excl. VAT	
						UVP zzgl. MwSt.	INLINER
39	33	75	30	8,9	A	28481	259,- 18603
46.5	43	90	34	14,9	B	28482	319,- 18605





NATURE meets ELEGANCE

ONLINE
DEAL



SUSTAINABLE PRODUCT!
Recycled Teak wood.

NACHHALTIGES PRODUKT!
Recyceltes Teak-Holz.



WOODY FLOOR PLANTERS / BODENGEFÄSSE

Ø	Ø	□	□	kg		sales price excl. VAT		
						UVP zzgl. MwSt.		INLINER
46	38,5	50	45	8,7	A	28486	198,-	18604
60	55	68	60	13,3	B	28487	319,-	18607



NEW!
NEU!

NEW!
NEU!



ARTFUL WOOD



A

SUSTAINABLE PRODUCT!
Recycled Teak wood.

NACHHALTIGES PRODUKT!
Recyceltes Teak-Holz.



B

ONLINE
DEAL



WOODY PLANTERS / PFLANZGEFÄSSE GLOBE

Ø	Ø	□	□	kg		sales price excl VAT	INLINER
						UVP zzgl. MwSt.	
50	25	40	38	6.3	A	28483	189.-
70	35	56	54	10.2	B	28484	18604
							18607



CRAFTED by NATURE



SUSTAINABLE PRODUCT!
Recycled Teak wood.

NACHHALTIGES PRODUKT!
Recyceltes Teak-Holz.

ONLINE
DEAL



NEW!
NEU!



ONLINE
DEAL



WOODY TABLE TOP VASE / TISCHGEFÄSSE

Ø	Ø	□	□	kg		sales price excl. VAT
						UVP zzgl. MwSt.
43	37	22	20	2,95	A	28485
75x26,5	70x23	26,5	25	4,3	B	28488
						135,-
						169,-



B



BANANAFLOOR PLANTERS / BODENGEFÄSSE

Ø	Ø	□	□	kg	banana	Sales price excl. VAT	
						UVP zzgl. MwSt.	INLINER
49	34	60	57	4	A 16832	375,-	18603
56	38	93	89	7.5	B 16757	595,-	18604



The vivid grain of the banana bark makes every single copy a unique piece of art.
 Die lebendige Maserung der Bananenstaudenrinde macht jedes Stück zu einem faszinierenden Unikat.



B

Perfect by nature.

Von Natur aus perfekt.



BANANA PLANTERS / PFLANZGEFÄSSE GLOBE

Ø	Ø	□	□	kg	banana	Sales price excl. VAT UVP zzgl. MwSt.
30	15,5	30	24	1,5	A 22935	125,-
50	18,5	40	38	3,5	B 22936	275,-
70	30	62	59	7	C 22937	495,-

GEWEIHFARN -
PLATYGERIUM
#24404
on page · auf Seite 227



BANANA

DIVISION LITE

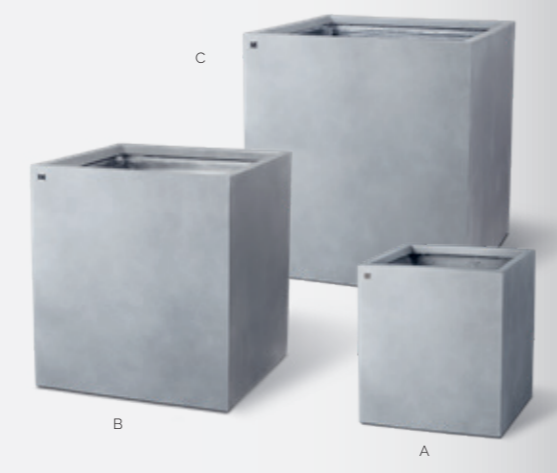

Swivel castors, each for Gelenkrollen, je Stück

#	Sales price excl. VAT UVP zzgl. MwSt.
19778	9,-

DIVISION LITE CUBE / PFLANZWÜRFEL

□	▣	▤	▥	natur beton	anthracite	Sales price excl. VAT UVP zzgl. MwSt.	Optional feet/castors Optionale Stellfüße/Rollen	INLINER
40 x 40	34 x 34	44	40	A 22335-N	F 22334-N	159,-	-	17897
50 x 50	44 x 44	54	50	B 22337-N	G 22336-N	239,-	-	18604
60 x 60	54 x 54	64	60	C 22339-N	H 22338-N	349,-	-	18606
80 x 80	72 x 72	60	56	D 28369-N	I 28368-N	619,-	4 pieces / Stück	
100 x 100	92 x 92	80	56	E 28367-N	J 28366-N	839,-	4 pieces / Stück	



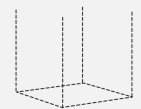

Easier planting thanks to the intermediate floor in the columns
Einfachere Bepflanzung dank Zwischenboden bei den Säulen.

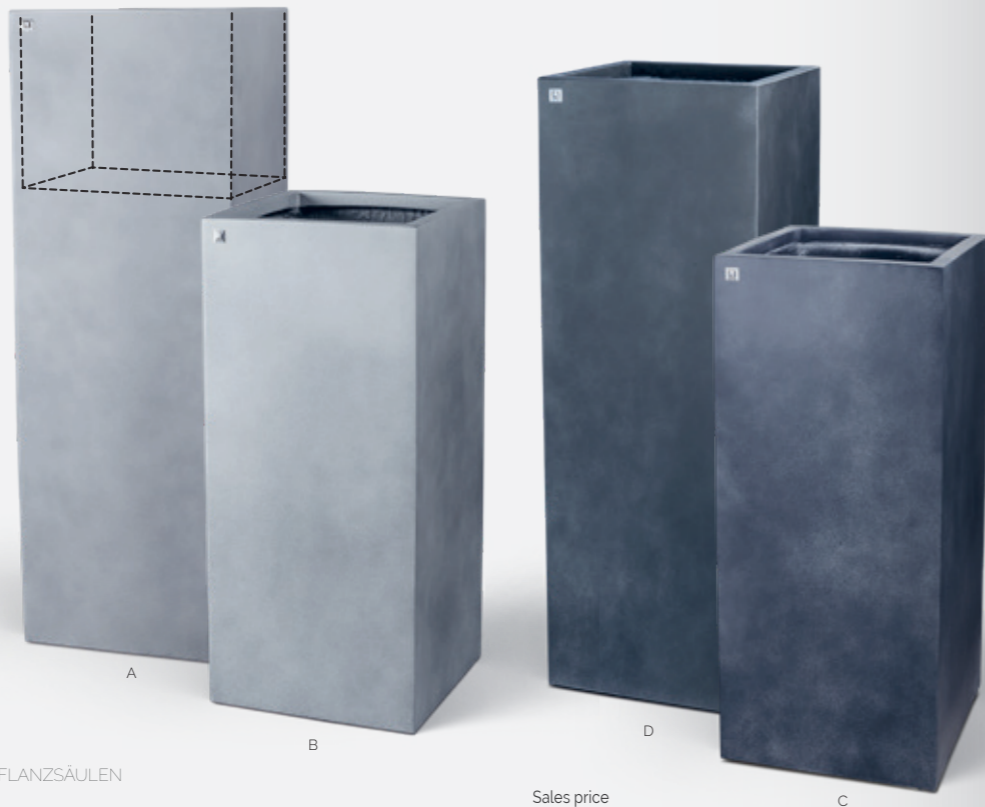

DIVISION LITE COLUMN PLANTERS / PFLANZSÄULEN

□	▢	□	▢	kg	concrete stone grey	concrete anthracite	Sales price excl. VAT	INLINER
35 x 35	30 x 30	80	40	14,2	A	C	UVP zzgl. MwSt.	17897
					22347-N	22346-N	215,-	
35 x 35	30 x 30	100	40	16,5	B	D	275,- <th>17897</th>	17897
					22343-N	22342-N		



Easier planting thanks to the intermediate floor

Einfachere Bepflanzung dank Zwischenboden

All room dividers have thread inserts for castors/feet |
Alle Raumteiler verfügen über Gewindeeinsätze für Rollen/Stellfüße



Swivel castors, each for Gelenkrollen, je Stück

#	Sales price excl. VAT
19778	UVP zzgl. MwSt.
	9,-

DIVISION LITE ROOM DIVIDERS / RAUMTEILER

□	▢	□	▢	kg	concrete stone grey	concrete anthracite	Sales price excl. VAT	Optional feet/castors
100 x 35	95 x 30	60	58	25,0	A	C	UVP zzgl. MwSt.	Optionale Stellfüße/Rollen
					22357-N	22356-N	379,-	5 pieces / Stück
100 x 35	95 x 30	80	40	32,0	B	D	479,- <td>5 pieces / Stück</td>	5 pieces / Stück
					22359-N	22358-N		

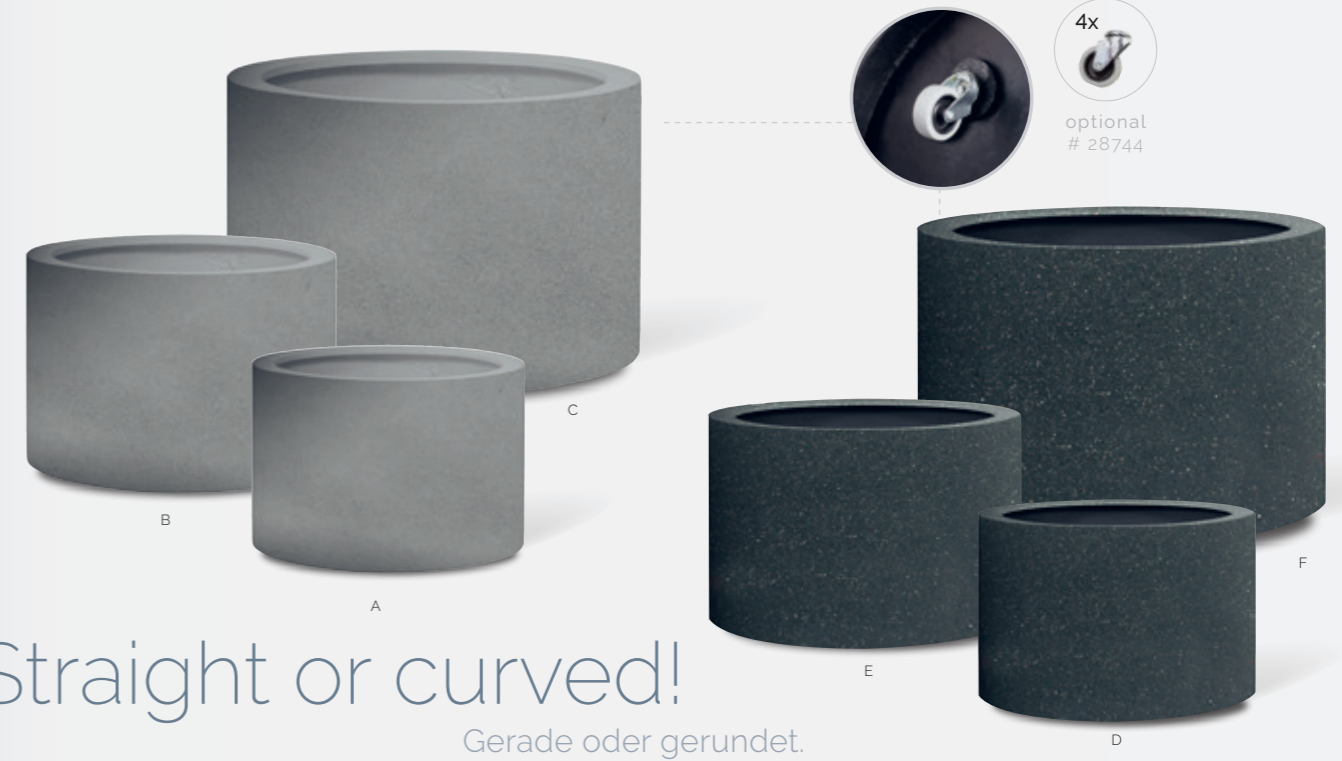

DEVISION LITE FLOOR PLANTER / BODENGEFÄSS CYLINDER

Ø	Ø	□	▣		concrete stone grey		concrete anthracite	Sales price excl. VAT UVP zzgl. MwSt.	INLINER	#	Sales price excl. VAT UVP zzgl. MwSt.
48	42	30	26	A	28717	D	28716	169,-	18605	-	-
60	52	40	36	B	28719	E	28718	298,-	18607	19778	9,-
80	52	60	36	C	28721	F	28720	449,-	18610		

DEVISION LITE FLOOR PLANTER / BODENGEFÄSS

Ø	Ø	□	▣		concrete stone grey		concrete anthracite	Sales price excl. VAT UVP zzgl. MwSt.	INLINER
55	37	46	34	G	28723	J	28722	219,-	18606
65	47	54	42	H	28725	K	28724	309,-	18608
80	47	66	42	I	28727	L	28726	459,-	18610

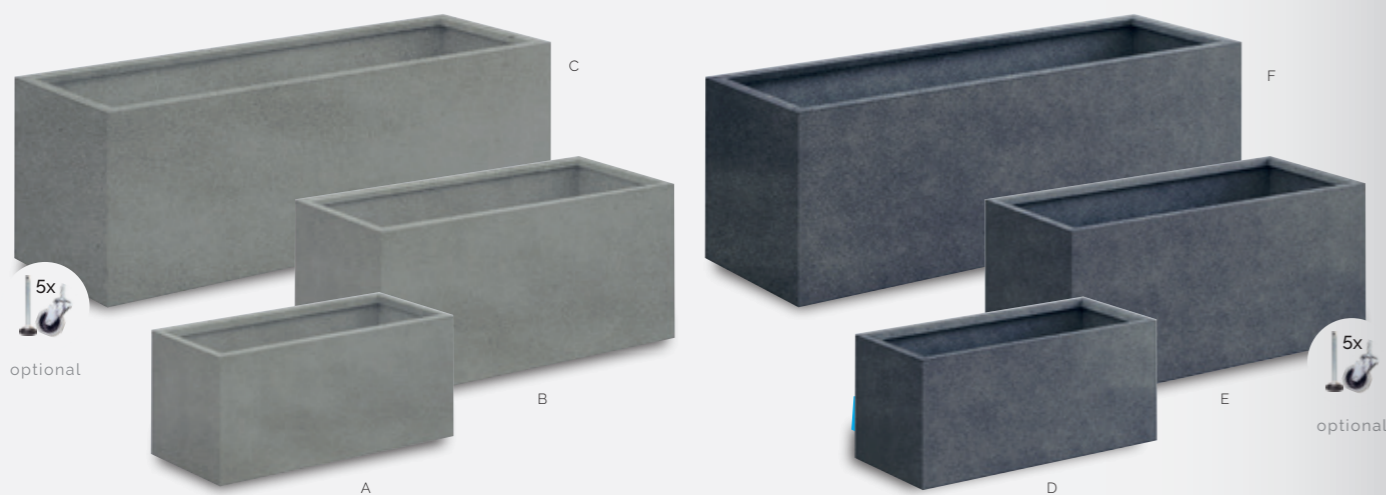

5x optional

5x optional



Swivel castors, each for Gelenkrollen, je Stück

#	Sales price excl. VAT UVP zzgl. MwSt.
19778	9,-

DIVISION LITE PLANTERS / PFLANZGEFÄSS

□	□	□	kg	stone grey	anthracite	Sales price excl. VAT UVP zzgl. MwSt.	Optional feet/castors Optionale Stellfüße/Rollen
80 x 35	35	32	13	A 28215-N	D 28216-N	265,-	5 pieces / Stück
100 x 45	45	42	15	B 28212-N	E 28213-N	395,-	5 pieces / Stück
150 x 50	50	46	36	C 28365-N	F 28364-N	665,-	6 pieces / Stück



SCHMETTERLINGSORCHIDEE - PHALAENOPSIS #24405 on page - auf Seite 215



DIVISION LITE PLANTERS / PFLANZGEFÄSS

∅	∅	□	□	kg	anthracite	stone grey	Sales price excl. VAT UVP zzgl. MwSt.	INLINER
27	23	30	28	2	A 28728	D 28729	98,-	17895
37	33	43	41	3	B 28730	E 28731	149,-	17897
49	44	55	53	5	C 28732	F 28733	209,-	18604



Super bowls!

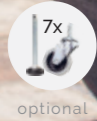

optional

A



Swivel castors, each for Gelenkrollen, je Stück

28744

Sales price excl. VAT UVP zzgl. MwSt. 9,-



optional

B

DIVISION LITE FLOOR PLANTERS / GROSSE PFLANZKÄSTEN

Ø	Ø	□	▣	kg	concrete stone grey	concrete anthracite	sales price excl. VAT UVP zzgl. MwSt.	Optional feet/castors Optionale Stellfüße/Rollen
100	90	50	42	18,0	B 24519-N	- 24541-N	598,-	5 pieces / Stück
120	110	60	52	31,0	- 24518-N	A 24540-N	798,-	7 pieces / Stück

Hidden castors and adjustable feet optionally available
Verdeckte Gelenkrollen und höhenverstellbare Stellfüße optional erhältlich



CRASSULA OVATA #20292 on page · auf Seite 219



Swivel castors, each for Gelenkrollen, je Stück

19778

Sales price excl. VAT UVP zzgl. MwSt. 9,-

DIVISION LITE PLANTER / PFLANZSCHALE CURVED

Ø	Ø	□	▣	kg	concrete stone grey	concrete anthracite	sales price excl. VAT UVP zzgl. MwSt.	Optional feet/castors Optionale Stellfüße/Rollen
55	45	22	22	5,5	A 28735	D 28734	198,-	-
73	59	30	30	10,5	B 28737	E 28736	259,-	4 pieces / Stück
95	78,5	44	41	17,5	C 28739	F 28738	398,-	4 pieces / Stück



NEW!
NEU!

STRIPE



A



CREME CHIC



B

ONLINE
DEAL



A



STRIPE FLOOR VASE / BODENVASEN

Ø	Ø	□	▣	kg	cream creme	sales price excl. VAT UVP zzgl. MwSt.	INLINER
40	34.5	75	33	9.3	A 28468	225,-	18603
48	41	90	33	15.6	B 28469	315,-	18605





NEW!
NEU!

STRIPE



CREME DE LA CREME



ONLINE
DEAL



STRIPE PLANTERS / PFLANZGEFÄSSE GLOBE

Ø	Ø	□	▣	kg	cream creme	sales price excl. VAT UVP zzgl. MwSt.	INLINER
50	27	40	37	7.4	A	28470	159.- 18604
70	37.5	56	52	14.3	B	28471	325.- 18607
75x26.5	68x21	26.5	24	6.8	C	28472	139.- -

CURVED RIVER RIVER

NEW!
NEU!



FREE FLOW



ONLINE DEAL



CURVED RIVER FLOOR VASE / BODENVASEN

Ø	Ø	□	□	kg	sales price excl. VAT		sales price excl. VAT		INLINER		
					bronze	UVP zzgl. MwSt.	black iron	UVP zzgl. MwSt.			
40	33.5	75	33	11.5	A	28458	355,-	C	28463	279,-	18603
48	41	90	35	14.2	B	28459	489,-	D	28464	389,-	18605

THE MAGIC OF CURVES

NEW!
NEU!

ONLINE
DEAL



CURVED RIVER PLANTERS / PFLANZGEFÄSSE GLOBE

Ø	Ø	□	□	kg	sales price excl. VAT		sales price excl. VAT		INLINER
					bronze	black iron	black iron	black iron	
50	27	40	36	4.5	A 28460	249,-	C 28465	198,-	18604
70	37	56	52	9.3	B 28461	495,-	D 28466	398,-	18607

FICUS ELASTICA GRÜN -
GUMMIBAUM
#20287
on page - auf Seite 223



NEW!
NEU!

FLOW
LIKE A BOAT



JADEBAUM
CRASSULA OVATA
#23855
on page · auf Seite 225



A



B



ONLINE
DEAL



CURVED RIVER TABLE TOP VASE / TISCHGEFÄSS

Ø	Ø	□	▣	kg	bronze	sales price excl VAT UVP zzgl. MwSt.	black iron	sales price excl VAT UVP zzgl. MwSt.
75x26,5	68x20	26,5	23	3,65	A 28462	235,-	B 28467	189,-



Amazing surface.
Faszinierende Oberfläche.



∅	∅	□	□	kg	black	Sales price excl. VAT UVP zzgl. MwSt.	INLINER
38	20	70	62	9.5	A 20672	199.-	17895
45	25	100	92	17	B 20673	335.-	18603
45	25	35	27	6.3	C 20674	159.-	17897
80	42	60	51	22.8	D 20675	505.-	18609
120	70	90	80	53.5	E 20676	1429.-	18610
75x25	63x15	25	21	4.6	F 21726	145.-	-





ALUMINIUM



E

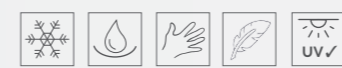

Ø	Ø	□	▣	kg	aluminium	Sales price excl. VAT	
						UVP zzgl. MwSt.	INLINER
38	20	70	62	6,5	A 20354	309,-	17895
45	25	100	92	12	B 20365	495,-	18603
45	25	35	27	5,3	C 20353	219,-	17897
80	42	60	51	16,8	D 20367	689,-	18609
120	70	90	80	42,5	E 20366	1.679,-	18610
75x25	63x15	25	21	3,7	F 21276	199,-	-





BOGENHANF -
SANSEVIERIA
CYLINDRICA
#20281
on page · auf Seite 227



BRONZE

F



B

A



RIVER PEBBLES ·
FLUSSKIESEL
#19852
on page · auf Seite 237

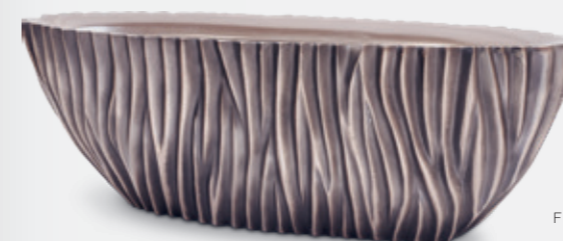

F

Ø	Ø	□	▣	kg	Sales price excl. VAT		
					bronze	INLINER	
					UVP zzgl. MwSt.		
38	20	70	62	6.5	A 21038	385,-	17895
45	25	100	92	12	B 21039	615,-	18603
45	25	35	27	5.3	C 21037	269,-	17897
80	42	60	51	16.8	D 21041	839,-	18609
120	70	90	80	42.5	E 21040	2.059,-	18610
75x25	63x15	25	21	3.7	F 21275	245,-	-



E

D

C



BLACK IRON



C



MATCHING INSERTS NOT INCLUDED!
PASSENDE EINSÄTZE NICHT INKLUSIVE!

INLINER

A	22985
B	22985
C	22985

180 cm



A



B



C



LOFT FLOOR VASE / BODENVASE

Ø	Ø	□	■	kg	black iron	sales price excl. VAT UVP zzgl. MwSt.
30	22	80	77	9.4	A 23065	209,-
31	22	100	97	11.7	B 23069	259,-
32	22	120	117	16	C 23073	275,-

"GOOD OLD" LOFT



MATCHING INSERTS NOT INCLUDED!
PASSENDE EINSÄTZE NICHT INKLUSIVE!

INLINER	
A	22985
B	22985
C	22985

180 cm



A



B



C



LOFT FLOOR VASE / BODENVASE

Ø	Ø	□	□	kg	aluminium	sales price excl. VAT UVP zzgl. MwSt.
30	22	80	77	9.4	A 23063	225,-
31	22	100	97	11.7	B 23067	275,-
32	22	120	117	16	C 23071	329,-



ALUMINIUM

A





BRONZE



MATCHING INSERTS NOT INCLUDED!
PASSENDE EINSÄTZE NICHT INKLUSIVE!

INLINER

A	22985
B	22985
C	22985



A



B



C



LOFT FLOOR VASE / BODENVASEN

Ø	Ø	□	■	kg	verdigris bronze	sales price excl. VAT UVP zzgl. MwSt.
30	22	80	77	9.4	A 23066	225,-
31	22	100	97	11.7	B 23070	275,-
32	22	120	117	16	C 23074	329,-

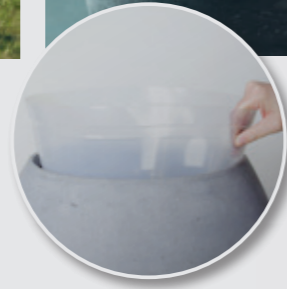

Passgenaue
Pflanzeinsätze
erhältlich.



NEW!
NEU!



LOFT FLOOR PLANTERS / BODENGEFÄSSE

Ø	Ø	□	□	kg	black iron	UVP zzgl. MwSt.	aluminium	verdigris bronze	UVP zzgl. MwSt.	INLINER
50	38	40	39	5.3	A 19412	229,-	C 19411	E 28495	275,-	18604
68	46	55	54	9.8	B 19414	398,-	D 19413	F 28496	499,-	18607

"GOOD OLD" LOFT



BLACK IRON



AMAZING GRACE



GRACE PFLANZGEFÄSSE

Ø	Ø	□	□	kg		champagner gold + patina	Sales price excl. VAT UVP zzgl. MwSt.	INLINER
31	23	70	56	8	A	24178	205,-	17895
37	29	90	76	13,5	B	24179	269,-	17896
52	44	120	106	17	C	24180	409,-	18605
41	33	41	39	4,5	D	24175	135,-	17897
50	42	50	48	5	E	24206	189,-	18605
67	59	67	65	7,5	F	24176	335,-	18606
80	72	80	78	16	G	24177	575,-	18608





CORTEN STEEL PLANTERS / RAUMTEILER

□	▣	□	▣	kg	rost	sales price excl. VAT UVP zzgl. MwSt.	INLINER	
78x28	74x24	78	76	23	A	28644	379,-	17896
118x38	114x34	118	116	61	B	28645	839,-	18603

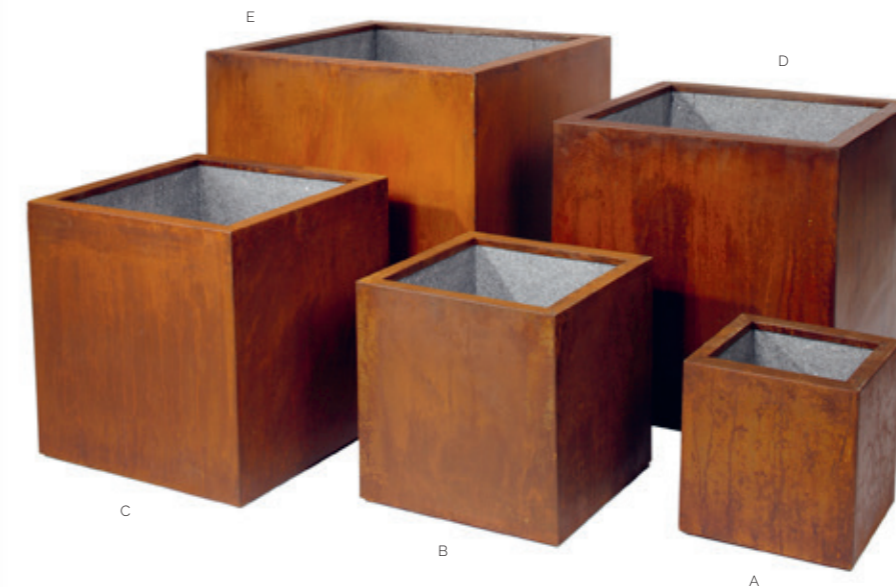

CORTEN STEEL PLANTERS / PFLANZWÜRFEL

□	▣	□	▣	kg	rost	sales price excl. VAT UVP zzgl. MwSt.	INLINER	
38	34	38	36	13.5	A	28639	209,-	18612
48	44	48	46	20.8	B	28640	319,-	18613
58	54	58	56	29.8	C	28641	429,-	18607
68	64	68	66	40.3	D	28642	559,-	18609
78	74	78	76	52.4	E	28643	719,-	18610

ORIGINAL CORTEN STEEL
Stable rust-like appearance
after exposure to the weather,
known for its corrosion resistance
and distinctive look.

2.0 mm material thickness
4 cm rim thickness

ORIGINAL CORTENSTAHL
Stabiler rostähnlicher Look
nach Witterungseinflüssen,
bekannt für seine Korrosionsbeständigkeit
und unverwechselbares Erscheinung.

2.0 mm Materialstärke
4 cm breiter Rand

LUNEA



LUNEA PLANTERS / PFLANZGEFÄSSE

Ø	Ø	□	□	kg	grey grau	sales price excl. VAT UVP zzgl. MwSt.	INLINER	
33	29.7	30	29	1.7	A	28527	63,-	17896
39	35	33	32	2.5	B	28526	75,-	17897
2er Set LUNEA					A-B	28525	125,-	BEST-PRICE %

HANDCRAFTED FROM
LIGHTWEIGHT ALUMINIUM

HANDGEFERTIGT AUS
LEICHTEM ALUMINIUM



NEW!
NEU!



KORBMARANTE - CALATHEA
#28439
on page - auf Seite 206

Mystical MOON LANDSCAPE



NEW!
NEU!



EINBLATT - SPATHIPHYLLUM
#28442
on page · auf Seite 206

PATINA

A



GRAVITA

HANDCRAFTED FROM
LIGHTWEIGHT ALUMINIUM

HANDGEFERTIGT AUS
LEICHTEM ALUMINIUM



GRAVITA FLOOR VASE / BODENVASEN

Ø	Ø	□	▣	kg	grey grau	sales price excl. VAT UVP zzgl. MwSt.	INLINER
44	36.5	69	67.5	5.7	A 28538	225.-	18607
64	52.6	89	88	10.5	B 28537	339.-	18604
2er Set GRAVITA					A-B 28536	505.-	BEST-PRICE %



GRAVITA PLANTERS / PFLANZGEFÄSSE

Ø	Ø	□	▣	kg	grey grau	sales price excl. VAT UVP zzgl. MwSt.	INLINER
39	30	36	35.7	2.9	C 28542	115.-	17897
54	42	45	44.7	4.9	D 28541	195.-	18605
70	57	56	55.4	8.3	E 28540	249.-	18608
3er Set GRAVITA					C-E 28539	505.-	BEST-PRICE %





OUTSTANDING TURQUESA

HANDCRAFTED FROM
LIGHTWEIGHT ALUMINIUM

HANDGEFERTIGT AUS
LEICHTEM ALUMINIUM



NEW!
NEU!



TURQUESA PLANTERS / PFLANZGEFÄSSE

Ø	Ø	□	▣	kg	sales price excl. VAT		INLINER		
					turquesa	UVP zzgl. MwSt.			
39	30	36	35.7	2.9	A	28546	98.-	17897	
54	42	45	44.7	4.9	B	28545	175.-	18605	
70	57	56	55.4	8.3	C	28544	225.-	18608	
3er Set TURQUESA					A-C	28543	449.-	BEST-PRICE %	-



NEW!
NEU!



ELEMENT GOLD

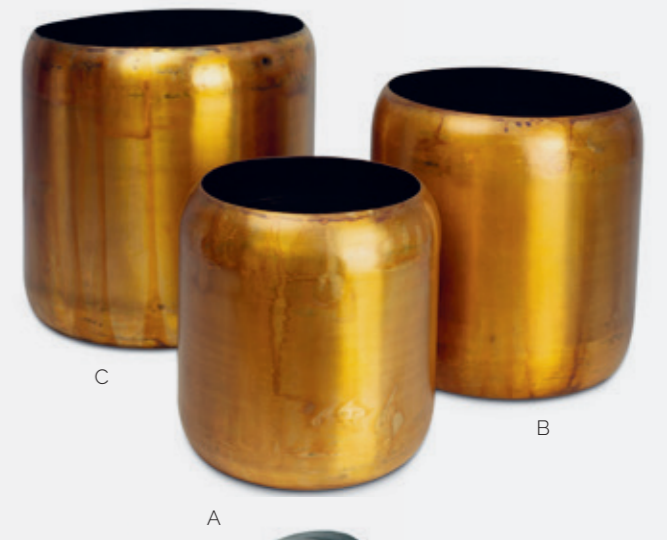

AURUM PLANTERS / PFLANZGEFÄSSE CYLINDER

Ø	Ø	□	▣	kg	sales price excl. VAT				
					gold	UVP zzgl. MwSt.	INLINER		
27	22,9	26	25,8	1,2	A	28535	35,-	19799	
33	28,7	31	30,8	1,9	B	28534	62,-	17897	
38	34	36	35,8	2,5	C	28533	79,-	18603	
3er Set AURUM					A-C	28532	159,-	BEST-PRICE %	-



HANDCRAFTED FROM
LIGHTWEIGHT ALUMINIUM

HANDGEFERTIGT AUS
LEICHTEM ALUMINIUM



ZAMIOCULCAS -
GLÜCKSFEDER
#28441
on page · auf Seite 225

AURUM PLANTERS / PFLANZGEFÄSSE

Ø	Ø	□	▣	kg	sales price excl. VAT				
					gold	UVP zzgl. MwSt.	INLINER		
29	21	26	25,6	1,6	D	28531	63,-	19799	
40	30	36	35,8	2,9	E	28530	109,-	17897	
54	41,7	44	43,8	4,9	F	28529	139,-	18605	
3er Set AURUM					D-F	28528	279,-	BEST-PRICE %	-



PANDORA

B

Fascinating PATINA.

The basis of the noble PANDORA planters is a fibreglass body, which has been coated with a gold leaf look. A counterweight in the bottom of the container ensures a secure stand.

Die Basis der edlen PANDORA Pflanzgefäße bildet ein Fiberglaskorpus, der mit einer Blattgold-Optik beschichtet wurde. Ein Kontergewicht im Gefäßboden sorgt für einen sicheren Stand.



False bottom for convenient planting
Zwischenboden für leichte Bepflanzung



A

C

B

D



PANDORA FLOOR VASES / BODENVASEN

Ø	Ø	□	□	kg	Sales price excl. VAT		INLINER
					gold leaf	UVP zzgl. MwSt.	
35	25	90	26	9.5	A 18420	345,-	17895
50	41	90	37	13	B 17308	515,-	18604
35	25	125	29	12	C 18422	449,-	17895
50	41	125	37	15.5	D 17311	669,-	18604
55	46.5	50	44	4.8	E 28419	385,-	18605
70	60.5	63.5	55	8.9	F 28422	588,-	18608



E

F

NEW!
NEU!



Decorative silver.

The basis of the noble PANDORA planters is a fibreglass body, which has been coated with a silver leaf look. A counterweight in the bottom of the container ensures a secure stand.

Die Basis der edlen PANDORA Pflanzgefäße bildet ein Fiberglaskorpus, der mit einer Blattsilber-Optik beschichtet wurde. Ein Kontergewicht im Gefäßboden sorgt für einen sicheren Stand.



False bottom for convenient planting
Zwischenboden für leichte Bepflanzung



PANDORA FLOOR VASES / BODENVASEN

Ø	Ø	□	□	kg	Sales price excl. VAT		INLINER
					silver leaf	UVP zzgl. MwSt.	
35	25	90	26	9,5	A 18419	345,-	17895
50	41	90	37	13	B 17307	515,-	18604
35	25	125	29	12	C 18421	449,-	17895
50	41	125	37	15,5	D 17310	669,-	18604
55	46,5	50	44	4,8	E 28420	385,-	18605
70	60,5	63,5	55	8,9	F 28423	588,-	18608



PANDORA

Pieces of ART. Kunstwerke.

Soberly considered, it is nothing more than a chemical reaction, but when you see the fascinating play of colours it creates – from orange to purple to iridescent violet and green-blue to shimmering anthracite – you can only marvel. The new PANDORA OXIDIZED vessels – true works of art.

Nüchtern betrachtet, ist es nichts weiter als eine chemische Reaktion, doch wenn man sieht, was für ein faszinierendes Farbenspiel dadurch entsteht – von Orange zu Purpur hin zu schillerndem Violett und Grünblau bis zu irisierendem Anthrazit – kann man nur noch staunen. Die neuen PANDORA OXIDIZED Gefäße – wahre Kunstwerke.



NEW!
NEU!



PANDORA FLOOR VASES / BODENVASEN

Ø	Ø	□	■	kg	brass oxidized Messing oxidiert	Sales price excl VAT UVP zzgl. MwSt.	INLINER
35	25	90	26	9,5	A 23090	389,-	17895
50	41	90	37	13	B 23818	569,-	18604
35	25	125	29	12	C 23819	498,-	17895
50	41	125	37	15,5	D 23820	735,-	18604
55	46,5	50	44	4,8	E 28421	425,-	18605
70	60,5	63,5	55	8,9	F 28424	645,-	18608

JADE PLANT
#23835
on page · auf Seite 225

ALOE WITH BLOSSOM
ALOE MIT BLÜTE
#23834
on page · auf Seite 215





CIGAR FLOOR PLANTERS · BODENGEFÄSSE

Ø	Ø	□	▣	kg	grey/grau	Sales price excl. VAT	INLINER
						UVP zzgl. MwSt.	
39	27,5	45	41	4,55	A 28417	155,-	17897
60	48	70	65	11,0	C 28418	415,-	18607
47	35	55	50	8,6	B 17909	275,-	18603
50	39	100	93	11,5	D 17910	445,-	18604
54	38	150	148	24,8	E 17911	595,-	18604



CIGAR

CIGAR OXIDIZED



MATCHING INSERTS NOT INCLUDED!
PASSENDE EINSÄTZE NICHT INKLUSIVE!

INLINER
20021

INLINER
20021

Ø	Ø	□	□	kg
42	30	94	64	6,5

mystic silver
24115

Sales price
excl. VAT
UVP zzgl. MwSt.
475,-



CALATHEA SURPRISE STAR
#23585
on page · auf Seite 221

MATCHING INSERTS NOT INCLUDED!
PASSENDE EINSÄTZE NICHT INKLUSIVE!

INLINER
20021

blue flame
24116

Sales price
excl. VAT
UVP zzgl. MwSt.
475,-





NEW!
NEU!



TALON PLANTERS / BODENVASE

Ø	Ø	□	□	kg	black	sales price excl. VAT UVP zzgl. MwSt.	INLINER
40	33.5	75	36	9,6	A 28455	249,-	18603
48	41.5	90	32	15,6	B 28456	349,-	18605
57	50.5	120	39	24,7	C 28457	539,-	18606



BLACK
BEAUTY



NEW!
NEU!



ELEGANT ALUMINIUM



TALON PLANTERS / BODENVASE

Ø	Ø	□	□	kg	aluminium	sales price excl. VAT UVP zzgl. MwSt.	INLINER
40	33.5	75	36	10.9	A 28452	289.-	18603
48	41.5	90	32	13.2	B 28453	409.-	18605
57	50.5	120	39	17.4	C 28454	639.-	18606



Upper class.
Oberklasse.

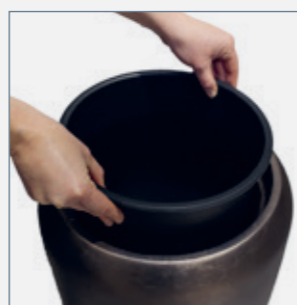

Removable plant insert included.
Herausnehmbarer
Pflanzeinsatz inklusive.

Easy planting and main-
tainance thanks to included
plant insert. *Einfaches
Bepflanzen dank integriertem
Pflanzeinsatz.*



ROYAL FLOOR PLANTERS / BODENVASE

Ø	Ø	□	□	kg	champagner-rosé	Sales price excl. VAT UVP zzgl. MwSt.
34	24	75	30	14,0	A 22126	315,-
34	24	97	30	19,0	B 22124	395,-
34	24	117	30	24,0	C 22122	479,-



HORSETAIL REED
SCHACHTELHALM
#21540
on page / auf Seite 211



ROYAL FLOOR PLANTERS / BODENVASE

Ø	Ø	□	□	kg	champagner-rosé	Sales price excl. VAT UVP zzgl. MwSt.
37	24	80	30	11	A 22120	349.-
46	27	100	30	16,5	B 22118	529.-

Supplied with removable
plant insert. Herausnehmbarer
Pflanzeinsatz inklusive.

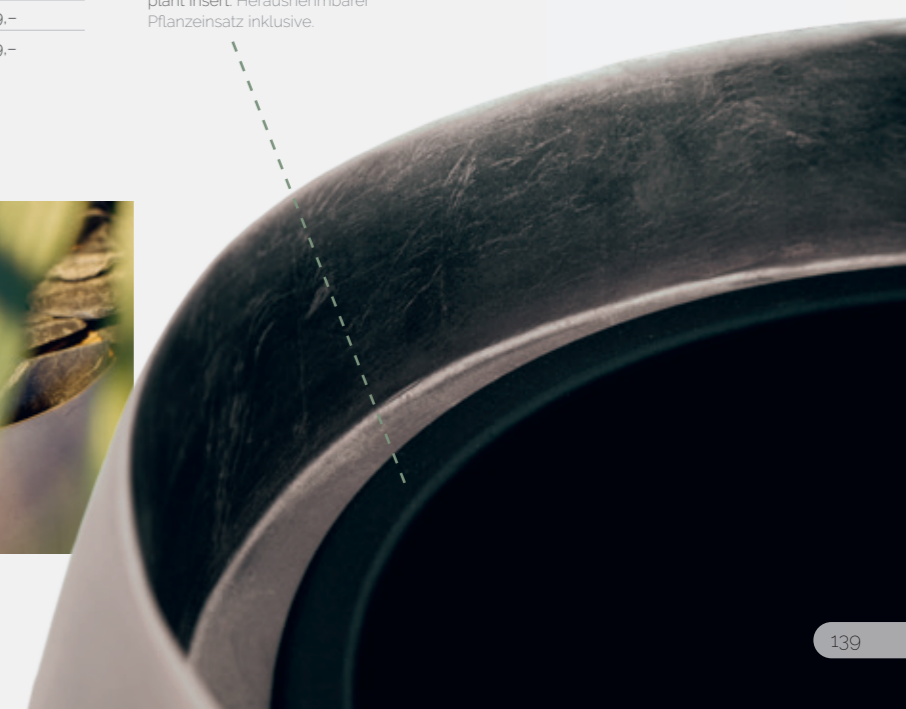

FICUS BONSAI
#23573
on page auf Seite 219



Impressive. Beeindruckend.

ROYAL is one of our most popular series.
A silver leafed body with an impressive
color finish and a unique matt coating.

ROYAL ist eine unserer beliebtesten Serien.
Ein blattversilberter Korpus mit beeindruckender
Farbgebung und einzigartigem Matt-Finish.

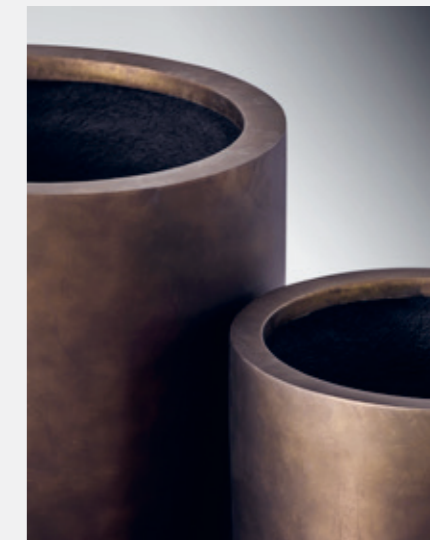

ROYAL PLANTERS / PFLANZGEFÄSSE

Ø	Ø	□	□	kg		bronze	champagner rosé	Sales price excl. VAT UVP zzgl. MwSt.	INLINER
36	30	55	53	4.0	A	24066	C 24065	239,-	17897
46	38	67	66	6.0	B	24064	D 24063	385,-	18604

Flat bottom shape.

Flachbodenform.

The flat bottom shape is ideal for large and high plants that need a secure stand. In this way you can also give large solitary plants an impressive appearance. ROYAL is one of our most popular series. A silver leafed body with an impressive color finish and a unique matt coating.

Besonders für große und hohe Bepflanzungen, die einen sicheren Stand brauchen, ist die Flachbodenform ideal. So verschaffen Sie auch großen Solitärpflanzen einen beeindruckenden Auftritt. ROYAL ist eine unserer beliebtesten Serien. Ein blattversilberter Korpus mit beeindruckender Farbgebung und einzigartigem Matt-Finish.



URBAN

OLIVE TREES
OLIVENBÄUME
#23586
on page · auf Seite 231



ROYAL

ROYAL FLOOR PLANTERS / BODENGEFÄSSE

Ø	Ø	□	□	kg	bronze	champagner rosé	Sales price excl. VAT UVP zzgl. MwSt.	INLINER
50	43	45	43	5,5	A 24062	C 24060	335,-	18605
65	56	58	57	9,5	B 24061	D 24059	499,-	18607

Discreet.
Dezent.



SUCCULENT
#23582
on page · auf Seite 227

B



A



D

C



B



ROYAL PLANTERS / PFLANZGEFÄSSE

Ø	Ø	□	■	kg	Sales price excl VAT		INLINER	
					champagner-rosé	UVP zzgl. MwSt.		
17	13	24	9	1.5	A	23086	55,-	-
30	18	24	20	1.0	B	23088	119,-	17895
40	26	32	30	2.5	C	22114	175,-	17897
60	42	43	40	4.5	D	22112	355,-	18604



CRASSULA OVATA
#20292
on page · auf Seite 219

B

ROYAL



A



Inside is matt coated!
Can be used as a decorative bowl as well.
Innen matt lackiert!
Auch als Dekoschale einsetzbar.



B



A



ROYAL TABLE PLANTERS / TISCHGEFÄSSE

Ø	Ø	□	□	kg	champagner-rosé champagne-rosé	Sales price excl. VAT UVP zzgl. MwSt.
48 x 22	38 x 15	17	15	1,5	A 22106	99,-
65 x 13	63 x 11	15	10	1,5	B 22110	125,-

High-class.
Hochklassig.



ROYAL PEDESTALS · BOWLS / PODESTE · SCHALEN

∅	∅	□	□	kg	champagner-rosé	Sales price excl. VAT UVP zzgl. MwSt.
42	30	14	13	1,5	A 22102	125,-
55	43	18	17	3,5	B 22100	165,-
35 x 35	-	100	-	18,5	C 22116	579,-



ROYAL

B

E



NEW!
NEU!



Grand großartig

Variable
PFLANZTIEFE
47 oder 179 cm



180 cm



GRAND PLANTER / PFLANZGEFÄSS

Ø	Ø	□	□	kg	sales price excl VAT UVP zzgl. MwSt.	
85	77	183.5	47/179	40	28451	1298,-

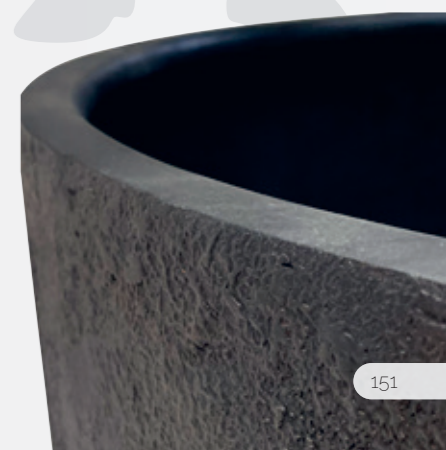



FERN FARN
#23570
on page - auf Seite 217

A

UNIQUE

Einzigartig

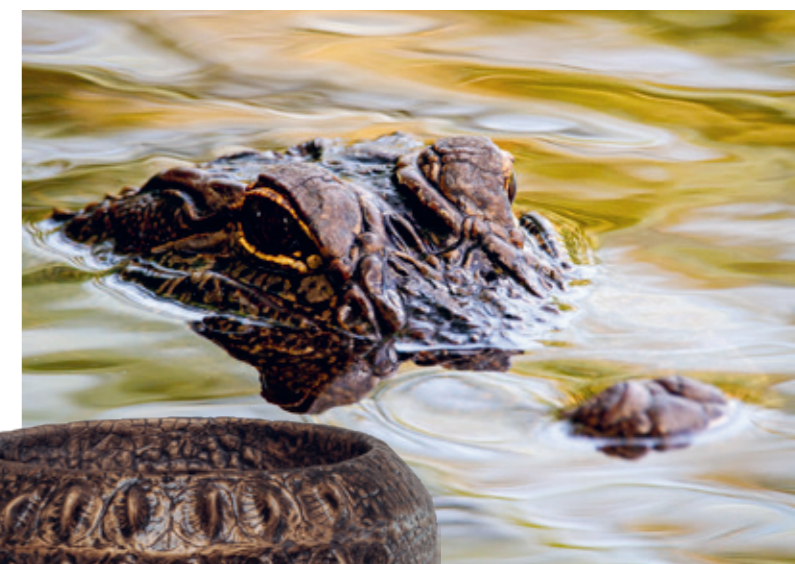

A

B



CROC FLOOR PLANTERS / BODENGEFÄSSE

Ø	Ø	□	□	kg	bronze	Sales price excl. VAT UVP zzgl. MwSt.	INLINER
47	36	56	50	6,5	A 24578	289,-	18605
50	39	100	95	21,5	B 26992	598,-	18605



ALOE WITH BLOSSOM
ALOE MIT BLÜTE
#23834
on page · auf Seite 215

ROCKY



BEGONIA
#24395 #23572
on page · auf Seite 219

Raw beauties.
Rauhe Schönheiten.

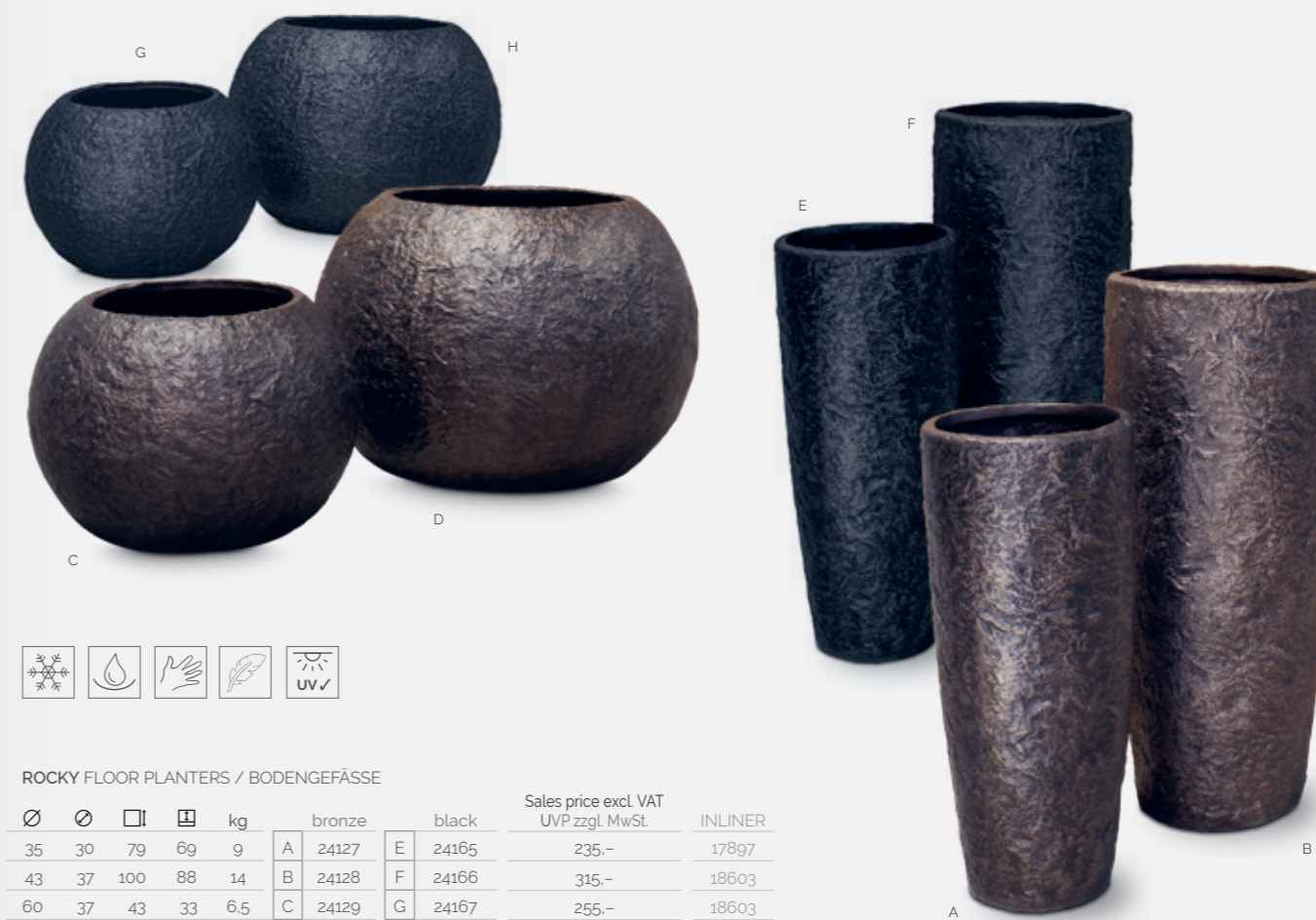

ROCKY FLOOR PLANTERS / BODENGEFÄSSE

Ø	Ø	□	▣	kg		bronze	black	Sales price excl. VAT UVP zzgl. MwSt.	INLINER
35	30	79	69	9	A	24127	E 24165	235.-	17897
43	37	100	88	14	B	24128	F 24166	315.-	18603
60	37	43	33	6.5	C	24129	G 24167	255.-	18603
80	48	57	52	10.5	D	24130	H 24168	375.-	18605



DO DAN TREE
#24402
on page · auf Seite 229



CORAL

STAGE SÄULE
#23056 #23050
on page · auf Seite 191



CORAL PLANTERS / PFLANZGEFÄSSE

Ø	Ø	□	▣	kg	bronze patina	Sales price excl. VAT UVP zzgl. MwSt.	INLINER
41	35	41	38	5	A 25375	165,-	18603
50	49	50	48	6,5	B 25376	239,-	18605
67	63	67	62	12	C 25526	409,-	18608
80	78	80	77	16,5	D 25527	598,-	18610

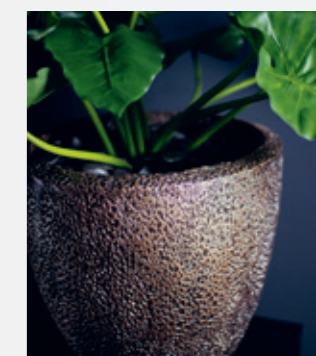



ANTHURIUM
#24399
on page · auf Seite 204

MEDINILLA
#23842
on page · auf Seite 215



CORAL.

bronze patina



CORAL FLOOR VESSELS / BODENVASEN

Ø	Ø	□	▣	kg	bronze patina	Sales price excl. VAT	
						UVP zzgl. MwSt.	INLINER
31	24	70	65	11	A 25528	279,-	17896
37	29	90	85	16,5	B 25529	365,-	18614
52	42	120	115	21	C 25530	498,-	18605

VERY COOL



ARTIC STONE PLANTERS / GEFÄSSE

Ø	Ø	□	□	kg	stone finish	sales price excl. VAT UVP zzgl. MwSt.	INLINER
48	35	100	95	13,8	A	28391 319,- €	18614
31	23	70	65	5,8	B	28392 179,- €	17895
63	44	68	64	12,7	C	28393 319,- €	18605
43	28	47	44	4,2	D	28394 179,- €	17896

NEW!
NEU!

ARTIC STONE





NEW!
NEU!

ATLANTIS



BRONZE oxydized

EUCALYPTUS
#24402
on page - auf Seite 225



ARTIC STONE PLANTERS / GEFÄSSE

Ø	Ø	□	□	kg	stone finish	sales price excl VAT UVP zzgl. MwSt.	INLINER
80	72	80	78	16	A 28401	598,- €	18610
67	59	67	65	7.5	B 28400	335,- €	18608
50	42	50	48	5	C 28399	209,- €	18605
41	33	41	39	2.5	D 28395	135,- €	18604
52	44	120	106	17	E 28398	419,- €	18605
37	29	90	76	13.5	F 28396	298,- €	17897
31	23	70	56	8	G 28397	225,- €	17896



SUCCULENT
#23582
on page · auf Seite 227



A4

B4



A3

A1

A2

B3

B1

B2



LAVA FLOOR PLANTERS / BODENGEFÄSSE

Ø	Ø	□	□	kg		Sales price excl. VAT		grey wash	Sales price excl. VAT		
						bronz patina	UVP zzgl. MwSt.		INLINER	UVP zzgl. MwSt.	
29	23	38	34	3	A1	24862	145,-	B1	24863	115,-	17896
44	37	53	47	7	A2	24860	235,-	B2	24866	185,-	18604
46	40	40	40	6	A3	24859	215,-	B3	24865	169,-	18604
56	49	103	49	21	A4	27386	529,-	B4	27387	429,-	18606



STAGHORN FERN
GEWEIHFARN
#24404
on page · auf Seite 227

LAVA





MEDINILLA
#23842
on page · auf Seite 215

MAGNIFICO



FICUS ELASTICA
#20287
on page · auf Seite 223



FLOWERING ALOE
BLUHENDE ALOE
#24406
on page · auf Seite 215

D

D

B

C



RIVER PEBBLES ·
FLUSSKIESEL
#19849
on page · auf Seite 237



MAGNIFICO PFLANZGEFÄSSE

Ø	Ø	□	▣	kg	antique bronze antik-bronze	Sales price excl. VAT		INLINER
						UVP zzgl. MwSt.		
47	43	40	37	2,9	A	24181	179,-	18604
56	49	47	45	4	B	24204	239,-	18606
35	31	72	70	8,6	C	24182	315,-	18614
46	42	92	90	12	D	24183	389,-	18604



D



ONION GRASS
ZWIEBELGRAS
#21804
on page - auf Seite 213



Shell

An impressive
statement
of good taste.

Ein eindrucksvoller Beweis
guten Geschmacks.



SHELL FLOOR PLANTERS / MUSCHEL BODENVASE

Ø	Ø	□	□	kg	M. o. p. white	Sales price excl. VAT UVP zzgl. MwSt.	INLINER
40	30	77	73	10	A 19496	439,-	17896
50	37	96	93	15.5	B 19498	625,-	18603
74	57	140	138	35	C 20374	1.395,-	18606



ALOCASIA CALIDORA
#23839
on page - auf Seite 221

HANDCRAFTED



SHELL FLOOR PLANTERS / MUSCHEL BODENVASE

Ø	Ø	□	□	kg	M. o. p. brown	Sales price excl VAT UVP zzgl. MwSt.	INLINER
40	30	77	73	10	A 19495	439.-	17896
50	37	96	93	15.5	B 19497	625.-	18603
74	57	140	138	35	C 20373	1.395.-	18606

Natural harmony.



Natürlich harmonisch.



SHELL PLANTERS / MUSCHEL GEFÄSSE

Ø	Ø	□	kg	M. o. p.		Sales price excl. VAT UVP zzgl. MwSt.	INLINER
				brown	white		
36	24	25	3,5	A	C	119.-	17896
52	30	37	7	B	D	249.-	18604

SCHMETTERLINGSORCHIDEE -
PHALAENOPSIS
#24405
on page · auf Seite 215



Schillernde Farben.



Mother-of-pearl, seaborn jewelry

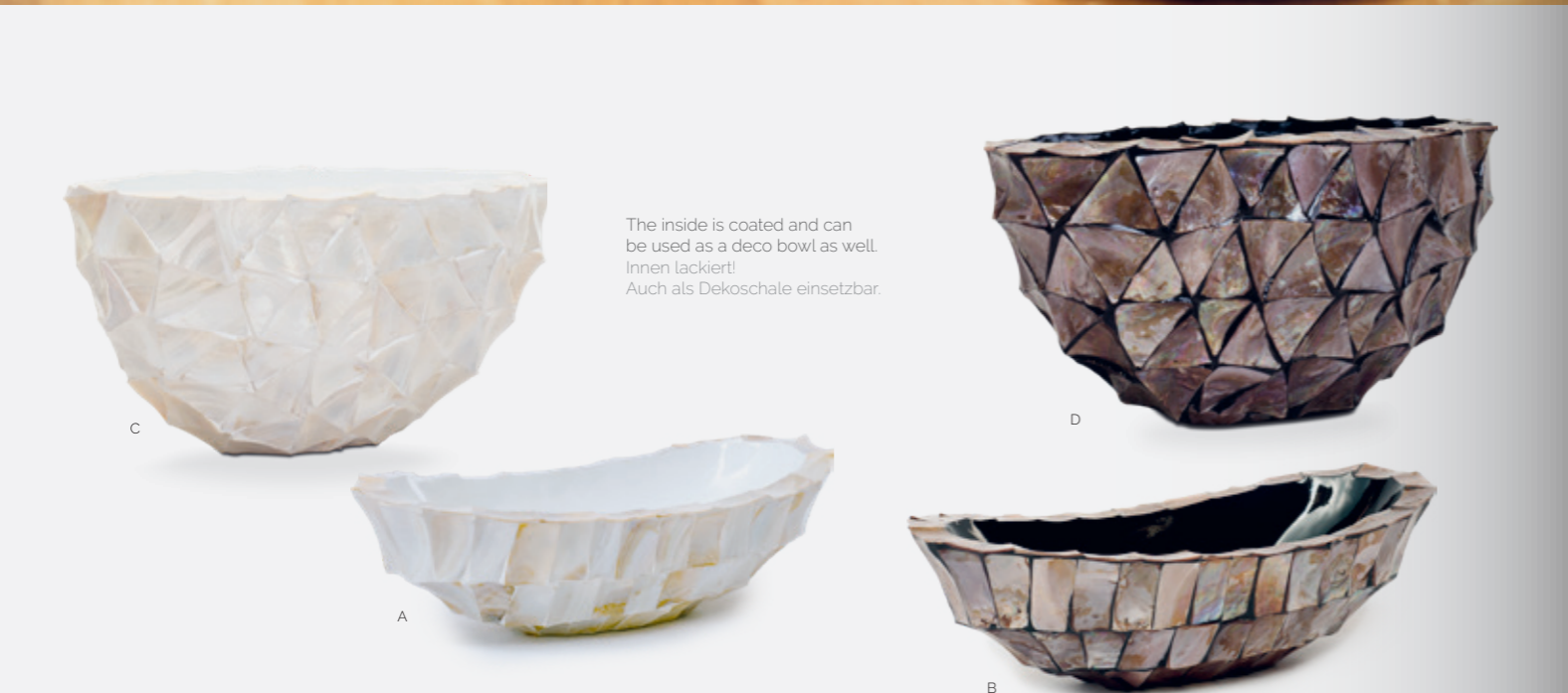

The inside is coated and can be used as a deco bowl as well. Innen lackiert! Auch als Dekoschale einsetzbar.

SHELL BOWLS / MUSCHEL SCHALEN

Ø	Ø	□	□	kg	M. o. p. white	M. o. p. brown	Sales price excl. VAT UVP zzgl. MwSt.
46 x 20	43 x 14	13	9	1.4	A 21102	B 21103	125,-
60 x 26	53 x 20	30	25	6	C 22209	D 22210	265,-



Perlmutter, ein Juwel aus dem Meer.



SHELL BOWLS / MUSCHEL SCHALEN

Ø	□	kg	M. o. p. brown	M. o. p. white	Sales price excl. VAT UVP zzgl. MwSt.
40	24	3.5	E 19580	G 19581	249,-
60	33	7.8	F 19582	H 19589	398,-



With intermediate bottom for orchids!
Mit Zwischenboden für Orchideen!



SHELL ORCHID PLANTER / MUSCHEL ORCHIDEENTOPF

Ø	Ø	□	▣	kg	M.o.p. brown	M.o.p. white	Sales price excl. VAT UVP zzgl. MwSt.
17	12	24	12	1.5	A 19649	B 19650	65,-

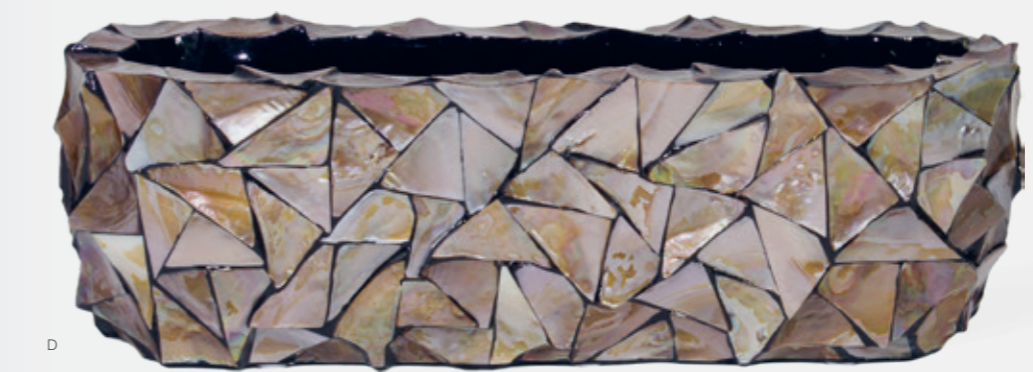

SHELL TABLE PLANTERS / MUSCHEL TISCHGEFÄSSE

Ø	Ø	□	▣	kg	M. o. p. brown	M. o. p. white	Sales price excl. VAT UVP zzgl. MwSt.
60 x 15	56 x 12	18	17	4	D 19651	E 19652	149,-

EXECUTIVE
STYLE
GEHOBENER STIL

ALOCASIA
#28429
on page · auf Seite 220

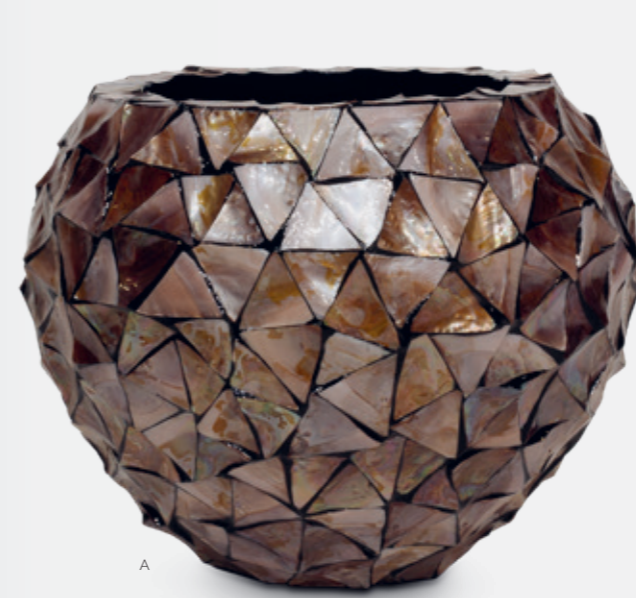

A



B

BIGGER.



C



D



SHELL PLANTERS / MUSCHEL GEFÄSSE

Ø	Ø	□	□	kg	M. o. p. brown	M. o. p. white	UVP zzgl. MwSt. sales price excl. VAT	INLINER
60	39	50	46	14.5	A 24371	C 24372	399,-	18605
70	40	60	55	19	B 24374	D 24375	585,-	18607

NEW!
NEU!



PARADIESVOGELBLUME -
STRELITZIE
#28430
on page - auf Seite 205

GREEN
ESCAPE

ALL VASES
ARE AVAILABLE
IN 3 SIZES



NEW!
NEU!



Flora



Gritto

Graphit



Pottery



PLANTERS / PFLANZGEFÄSSE

Ø	Ø	□	□	FLORA anthrazit		FLORA grau		FLORA weiß		GRITTO anthrazit		GRITTO grau		GRAPHIT		POTTERY anthrazit		POTTERY grau		sales price excl. VAT UVP zzgl. MwSt.	INLINER	
				A-1	28618	B-1	28622	C-1	28626	D-1	28605	E-1	28609	F-1	28614	G-1	28630	H-1	28634			G-2
37	35	30	27	A-2	28617	B-2	28621	C-2	28625	D-2	28604	E-2	28608	F-2	28613	G-2	28628	H-2	28632	49,-	18603	
44	42	36	33	A-3	28616	B-3	28620	C-3	28624	D-3	28603	E-3	28607	F-3	28612	G-3	28627	H-3	28631	79,-	18604	
55	53	43.5	53	A	28615	B	28619	C	28623	D	28602	E	28606	F	28611	G	28627	H	28631	99,-	18696	
3er Set																					205,-	BEST PRICE %

NEW!
NEU!



FENSTERBLATT -
MONSTERA
#28448
on page · auf Seite 206

GREEN
ESCAPE



NEW!
NEU!



ALL VASES
ARE AVAILABLE
IN 3 SIZES

Linea



Petal



PLANTERS / PFLANZGEFÄSSE

Ø	Ø	□	□	LINEA anthrazit	LINEA grau	LINEA weiß	PETAL anthrazit	PETAL weiß	PETAL grau	sales price excl VAT	INLINER	
37	35	30	27	A-1	B-1	C-1	D-1	E-1	F-1	UVP zzgl. MwSt		
				28585	28589	28593	28597	28638	28601	49,-	18603	
				A-2	B-2	C-2	D-2	E-2	F-2	79,-	18604	
				28584	28588	28592	28596	28637	28600			
				A-3	B-3	C-3	D-3	E-3	F-3	99,-	18696	
				28583	28587	28591	28595	28636	28599			
				3er Set	A	B	C	D	E	F	205,-	BEST PRICE %
				28582	28586	28590	28594	28635	28598			



CLASSIC SHAPES WITH INTERESTING GRANITE SURFACE
KLASSISCHE FORM MIT INTERESSANTER GRANIT OBERFLÄCHE



anthracite/anthrazit

A

B

C



nature/natur

F

E

D



CLIFF PLANTERS / PFLANZGEFÄSS

Ø	⊗	□	▣	kg	anthracite RAL 7021	stone grey RAL 7030	Sales price excl. VAT UVP zzgl. MwSt.	INLINER
27	23	30	28	2	A	D	98,-	17896
37	33	43	41	3	B	E	149,-	18603
49	44	55	53	5	C	F	209,-	18605

CLIFF



ALOE
Art. # 24406
on page · auf Seite 215





FENSTERBLATT - MONSTERA
#28448
on page · auf Seite 206



CORUM



A1 A2



B1 B2



C1 C2



All CORUM planters come in a matte colour finish

Alle CORUM Gefäße zeichnen sich durch ein mattes Farbfinish aus.

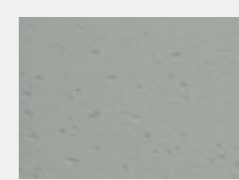

stone grey RAL 7030



olive grey RAL 7002

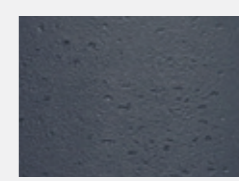

anthracite RAL 7021



CORUM PLANTERS / PFLANZGEFÄSSE

Ø	□	■		stone grey RAL 7030	olive grey RAL 7002	anthracite RAL 7021	Sales price excl. VAT UVP zzgl. MwSt.	INLINER
39	37	36	A1	27706	B1 27704	C1 27705	139,-	18603
48.5	46.5	46	A2	27709	B2 27707	C2 27708	198,-	18605



FÄCHERPALME
#24410
on page · auf Seite 208

BOGENHANF -
SANSEVIERIA CYLINDRICA
#20281
on page · auf Seite 227

GEWEIHFARN - PLATYCERIUM
#24404
on page · auf Seite 227

CONICAL

concrete finish

A1

C2

B3



A3

A2

A1

B3

B2

B1



C3

C2

C1



CONICAL CONCRETE FINIS PLANTERS / PFLANZGEFÄSSE

Ø	Ø	□	□	kg	Sales price excl. VAT			INLINER				
					anthracite RAL 7021	stone grey RAL 7030	traffic white RAL 9016					
40	34	35	35	2,5	A1	27810	B1	27796	C1	27797	119,-	18603
50	42	40	39	3,5	A2	27809	B2	27801	C2	27802	159,-	18605
58	49	50	48	4	A3	27808	B3	27806	C3	27807	198,-	18607

Sales price excl. VAT
UVP zzgl. MwSt.

INLINER



SHELL BOWLS / SCHALEN
#19581
on page · auf Seite 175

Staged.

In Szene gesetzt.



STAGE PEDESTALS / PODESTE

Light-weight yet sturdy platforms in matt powder-coated metal.

Leichtgewichtige und dennoch stabile Podeste aus matt pulverbeschichtetem Metall.

□	□	kg	black schwarz		white weiß		Sales price excl VAT UVP zzgl. MwSt.
30 x 30	50	4.0	G	27998	N	27999	119.-
30 x 30	75	4.6	A	23048	H	23049	135.-
30 x 30	100	4.9	B	23050	I	23051	149.-
30 x 30	125	6.0	C	23052	J	23053	165.-
40 x 40	50	5.5	D	23054	K	23055	139.-
40 x 40	75	6.0	E	23056	L	23057	159.-
40 x 40	100	6.5	F	23058	M	23059	175.-

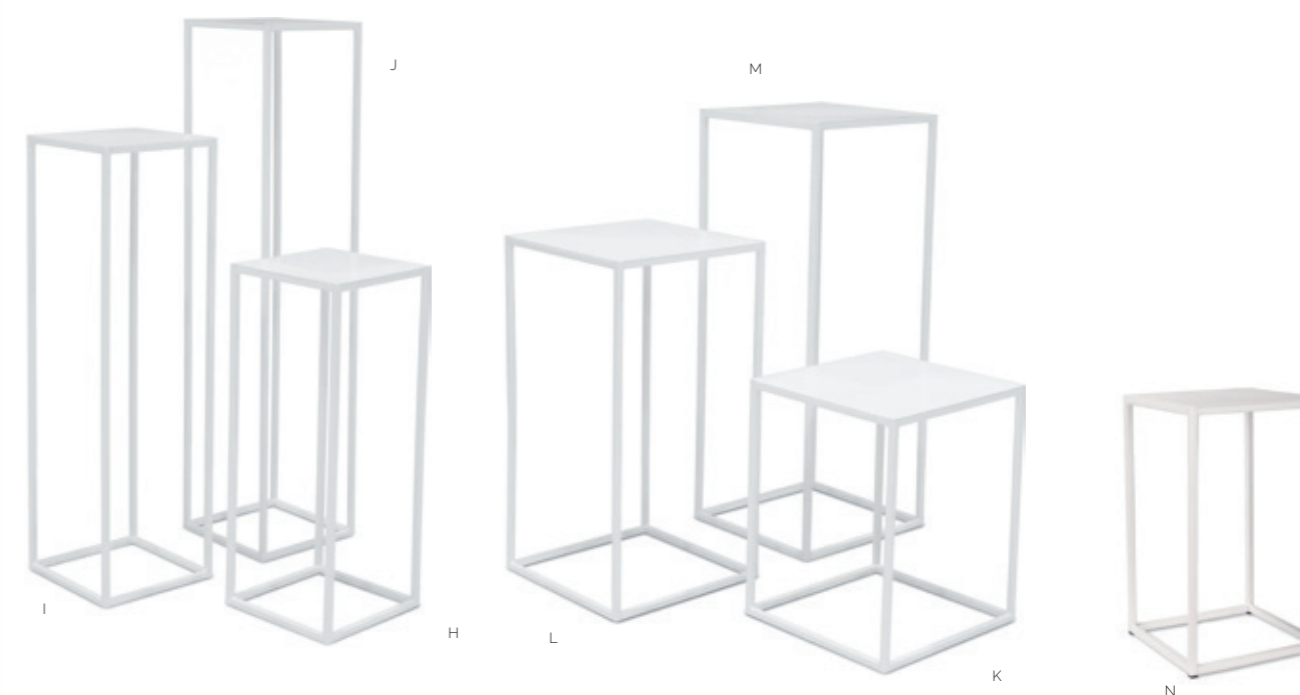



THE OPTIONS

DIE OPTIONEN

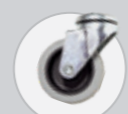

Hidden wheels
verdeckte Gelenkrollen
(19778)

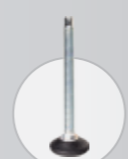

Hidden adjustable feet
verdeckte Stellfüße
(19780)

Cubes			
Divider			
Tower			
Pandora			
XL			
Globe			

Colours Farben		 RAL 7016 anthrazit-grau RAL 9016 weiß RAL 7039 Quarzgrau RAL 9005 schwarz		
Delivery time Lieferzeit	On stock auf Lager			
Surcharge Aufpreis	free kostenfrei	free kostenfrei	10-19 pcs / Stk. 25 % 20-49 pcs / Stk. 20 % 50-99 pcs / Stk. 5 % >= 100 pcs / Stk. free	25 %

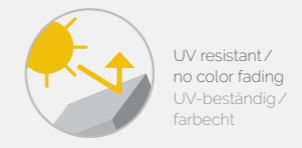
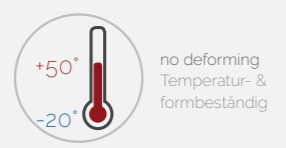

PREMIUM. 100% INDOOR OUTDOOR



Marine Quality. Marine-Qualität.



The planters of the fleur ami PREMIUM COLLECTION consist of a robust glass fibre reinforced plastic with a 2 mm thick gelcoat coating in marine quality. This durable composite material is characterised by its particularly high weather resistance, UV stability, chemical and acid resistance as well as high impact and scratch resistance. The material known from yacht building remains waterproof, crack-free and osmosis-resistant for years. The double-walled planters ensure tasteful planting both indoors and outdoors thanks to a drain with twist closure. Retracted intermediate bottoms and counterweights guarantee maximum user-friendliness for the high planters. Various optional accessories such as adjustable feet, base plates, swivel castors and screw foundation ensure more flexibility and increase the stability of the beautifully designed planters.

Die Pflanzgefäße der fleur ami PREMIUM COLLECTION bestehen aus einem robusten glasfaserverstärkten Kunststoff mit einer ca. 2 mm starken Gelcoat-Beschichtung in Marine-Qualität. Dieser langlebige Verbundwerkstoff zeichnet sich durch seine besonders hohe Witterungsbeständigkeit, UV-Stabilität, Chemikalien- und Säureresistenz, sowie eine hohe Schlag- und Kratzfestigkeit aus. Das aus dem Yachtbau bekannte Material bleibt auch über Jahre wasserundurchlässig, rissfrei und osmosebeständig. Die doppelwandigen Pflanzgefäße sorgen dank eines Abflusses mit Drehverschluss sowohl im Innen- als auch Außenbereich für eine geschmackvolle Begrünung. Eingezogene Zwischenböden und Kontergewichte garantieren maximale Benutzerfreundlichkeit bei den hohen Gefäßen. Verschiedene, optional erhältliche Zubehörartikel wie Stellfüße, Bodenplatten, Gelenkrollen und Schraubfundament sorgen für mehr Flexibilität und erhöhen die Standsicherheit der formschönen Pflanzgefäße.



Classical, cubical.

Klassisch kubisch.



New seamless production technique with visually improved, broader rim.
Neue nahtlose Fertigungstechnik mit schönerem, breiterem Rand.

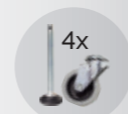

optional for all planters

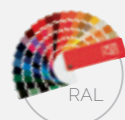

See first chapter page for color options and detailed material characteristics!
Farboptionen und ausführliche Materialeigenschaften siehe erste Kapitelseite!

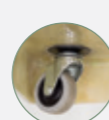

Hidden wheels and adjustable feet optionally available
Verdeckte Gelenkrollen und höhenverstellbare Stellfüße optional erhältlich



For/für A-C: casters - Gelenkrollen (1x)	19778	9,-
feet - Stellfüße (1x)	19780	3,50

PREMIUM PLANTER CUBE / PFLANZWÜRFEL

□	📏	□	□	kg	white Weiß	black Schwarz	RAL 7016 anthracite grey Anthrazitgrau	RAL 7039 quartz grey Quarzgrau	Sales price excl. VAT UVP zzgl. MwSt.	Optional feet/casters Optionale Stellfüße/Rollen
40x40	31	40	33	5.1	A 19957	20604	20648	20125	269,-	4 pieces / Stück
50x50	39	50	46	6.9	B 19958	20605	20581	20652	335,-	4 pieces / Stück
60x60	47	60	54	9.7	C 19959	20606	20582	20102	525,-	4 pieces / Stück
80x80	61.5	80	67	21.6	D 19960	20607	20583	20653	935,-	4 pieces / Stück
100x100	77	100	87	36.7	E 19961	20608	20584	20654	1679,-	4 pieces / Stück



CUBE





BIGGER.



A

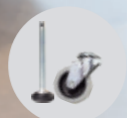

optional
for all planters



B

A

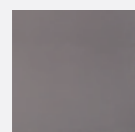
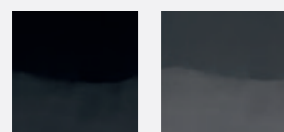

C



D



For/für A-D. casters · Gelenkrollen (1x)	19778	9,-
feet · Stellfüße (1x)	19780	3,50



See first chapter page for color options and detailed material characteristics!
Farboptionen und ausführliche Materialeigenschaften siehe erste Kapitelseite!

PREMIUM CLASSIC FLOOR PLANTER / BODENGEFÄSS

Ø	Ø	□	■	kg	white Weiß	black Schwarz	RAL 7016 anthracite grey Anthrazitgrau	RAL 7039 quartz grey Quarzgrau	Sales price excl. VAT UVP zzgl. MwSt.
100	84	50	37	13,5	A 23949	B 23952	C 23950	D 23951	805,-



XL. STYLE AT LARGE.





ONION GRASS
ZWIEBELGRAS
#21804
on page · auf Seite 213



DIVIDER



See first chapter page for color options and detailed material characteristics!
Farboptionen und ausführliche Materialeigenschaften siehe erste Kapitelseite!



optional for all planters

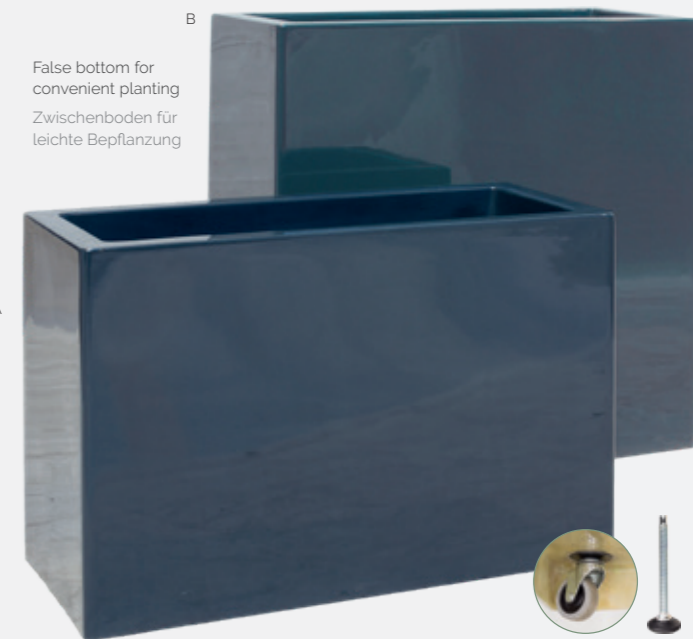

False bottom for convenient planting
Zwischenboden für leichte Bepflanzung



				kg	white Weiß	black Schwarz	anthracite grey Anthrazitgrau	quartz grey Quarzgrau	Sales price excl. VAT UVP zzgl. MwSt.	Optional feet/casters Optionale Stellfüße/Rollen
90 x 40	80 x 30	60	35	10,4	A 22310	22315	22325	22320	505,-	4 pieces / Stück
90 x 40	80 x 30	90	35	12,6	B 22311	22316	22326	22321	639,-	4 pieces / Stück

For/für A-D: casters · Gelenkrollen (1x)	19778	9,-
feet · Stellfüße (1x)	19780	3,50



TOWER

Seamless production technique with broad rim.
Nahtlose Fertigungstechnik mit schönem, breitem Rand.

False bottom for convenient planting
Zwischenboden für leichte Bepflanzung

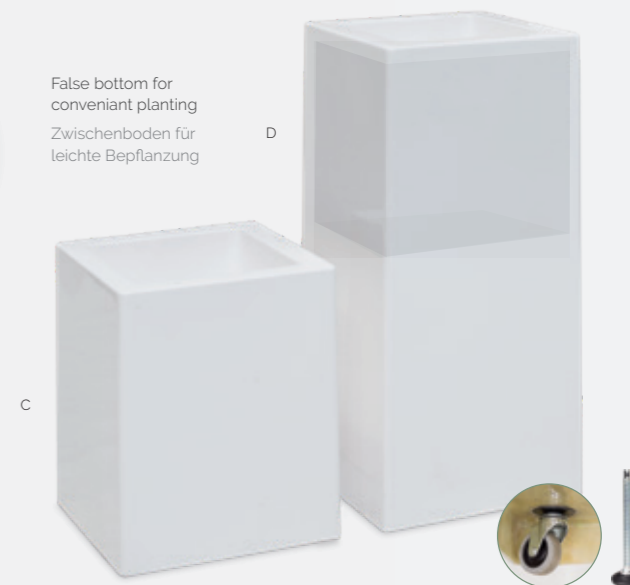

For/für A-D: casters · Gelenkrollen (1x)	19778	9,-
feet · Stellfüße (1x)	19780	3,50

				kg	white Weiß	black Schwarz	RAL 7016 anthracite grey Anthrazitgrau	RAL 7039 quartz grey Quarzgrau	Sales price excl. VAT UVP zzgl. MwSt.	Optional feet Optionale Stellfüße
40	30	50	36	5,1	C 22307	22312	22322	22317	315,-	4 pieces / Stück
40	30	90	36	6,5	D 22308	22313	22323	22318	449,-	4 pieces / Stück



All high PREMIUM planters with false bottom for convenient planting
Alle hohen PREMIUM Gefäße mit Zwischenboden für eine leichte Bepflanzung

Ø	Ø	□	□	kg	white Weiß	black Schwarz	RAL 7016 anthracite grey Anthrazitgrau	RAL 7039 quartz grey Quarzgrau	Sales price excl. VAT UVP zzgl. MwSt.
35	27	90	36	9.4	A 19969	19968	20591	20659	395.-
50	42	90	36	11.9	B 19971	19970	20592	20660	479.-
35	27	125	36	11.4	C 19973	19972	20593	20661	459.-
50	42	125	36	15.5	D 19975	19974	20594	20662	565.-



See first chapter page for color options and detailed material characteristics!
Farboptionen und ausführliche Materialeigenschaften siehe erste Kapitelseite!



PANDORA





See first chapter page for color options and detailed material characteristics!
Farboptionen und ausführliche Materialeigenschaften siehe erste Kapitelseite!



Ø	Ø	□	□	kg	white Weiß	black Schwarz	RAL 7016 anthracite grey Anthrazitgrau	RAL 7039 quartz grey Quarzgrau	Sales price excl. VAT UVP zzgl. MwSt.
40	22.5	32	26	2.1	A 19966	20613	20589	20657	250,-
60	33	45	40	5.0	B 19967	20614	20590	20658	459,-



GLOBE



Name	☐	☒	☒	☒	kg	#	sales price excl VAT UVP zzgl. MwSt.
Anthurium	81	20,5	19,5	12	3,3	A 24401	179,-
Fiddle	107	20,5	19,5	-	3,4	B 24400	185,-
NEU! Geigenfeige - Ficus Lyrata	152	18	16,5	76	3,1	C 28433	98,-
Bird of Paradise Leaf - Strelitzie BLATT	167	20,5	19,5	-	4,4	D 24403	259,-
Anthurium	65	14	13	12	2,0	E 24399	59,-
NEU! Paradiesvogelblume - Strelitzie ☀	122	16	13	13	3,1	F 28430	115,-



A



B



D



E



F



NEW!
NEU!

C



UV-STABIL
UV-RESISTANT



205



NEW!
NEU!



NEW!
NEU!



NEW!
NEU!



NEW!
NEU!



NEW!
NEU!

Name	☐	☒	☒	☒	kg	#	sales price excl. VAT UVP zzgl. MwSt.
NEU! Korbmarante - Calathea	90	19	18	25	10.2	A 28439	65,-
NEU! Einblatt - Spathiphyllum	90	23	20	18	4.9	B 28442	109,-
NEU! Fensterblatt - Monstera ☀	137	16	13	18	2.4	C 28432	80,-
NEU! Fensterblatt - Monstera	120	17	14	12	5.9	D 28447	149,-
NEU! Fensterblatt - Monstera	90	17	14	9	4.8	E 28448	105,-



NEW!
NEU!

JUNGLE

180 cm

NEW!
NEU!

D

E

F



G



GRACE
PFLANZGEFÄSSE
#24175
on page · auf Seite 110



DIVERSITY

A



NEW!
NEU!

B



NEW!
NEU!

C

Name	☐	🗑️	🗑️	🍃	kg	#	UVP zzgl. MwSt. sales price excl. VAT
Palmfarn Cycas	59	17	14	-	2.5	A 24409	115,-
NEU! Fächerpalme	99	13	12,5	9	1.8	B 28427	65,-
NEU! Dattelpalme - Phoenix Palm	142	13	12,5	18	2.2	C 28426	75,-
NEU! Goldfruchtpalme - Areca Palm	150	17	15	952	6.3	D 28445	215,-
NEU! Goldfruchtpalme - Areca Palm	182	20	17	24	4.3	E 28428	109,-
NEU! Goldfruchtpalme - Areca Palm	120	17	15	560	10.0	F 28444	142,-
Fächerpalme	140	20,5	19,5	-	4.3	G 24410	359,-

Name	□	☒	☒	kg	#	sales price excl VAT UVP zzgl. MwSt.
Zuckerrohr - Saccharum officinarum	122	19	16	2,1	A 21805	79,-
Zuckerrohr - Saccharum officinaru	180	25	21	4,5	B 21539	119,-
Schachtelhalm - Equisetum	120	13	12	2,3	C 21540	75,-

GRASS&CO.



Name	□	☒	☒	kg	#	sales price excl VAT UVP zzgl. MwSt.
Rohrkolben - Typhaceae	122	18	13	4,5	D 19002	99,-
Rohrkolben - Typhaceae	152	20	18	7,0	E 19003	149,-
Rohrkolben - Typhaceae	183	20	16	10,0	F 19004	179,-
Zwiebelgras Kunstpflanze	122	17	15	4,0	G 19005	99,-
Zwiebelgras Kunstpflanze	152	19	16	7,0	H 19006	149,-
Zwiebelgras Kunstpflanze	183	19	14	8,0	I 19007	179,-



Carefree
green

C



Creating atmosphere

LAVA FLOOR PLANTERS /
BODENGEFÄSSE
#24863 #24866
#24865 #27387
on page - auf Seite 164

Name	□	☒	☒	kg	#	UVP zzgl. MwSt. sales price excl. VAT
Zwiebelgras Kunstpflanze	90	25	20	2.55	A 21804	85,-
Zwiebelgras Kunstpflanze	76	23	18	1.7	B 21803	59,-
Zwiebelgras Kunstpflanze	60	18	14	1.4	C 19516	49,-
Zwiebelgras Kunstpflanze	91	18	14	1.5	D 19517	75,-
Zwiebelgras Kunstpflanze	153	17	15	2.2	E 19560	155,-
Fuchsschwanzgras - Alopecurus	120	17	14	2.2	F 18625	109,-
Fuchsschwanzgras - Alopecurus	90	16	14	1.5	G 18624	75,-
Fuchsschwanzgras - Alopecurus	60	18	14	0.8	H 18623	39,-
Zwiebelgras Kunstpflanze	122	20	16	4.0	J 19008	109,-
Zwiebelgras Kunstpflanze	152	20	20	6.0	K 19000	165,-



ROCKY FLOOR PLANTERS /
BODENGEFÄSSE
#24167
on page · auf Seite 155



C



I



D

E



F

G



H

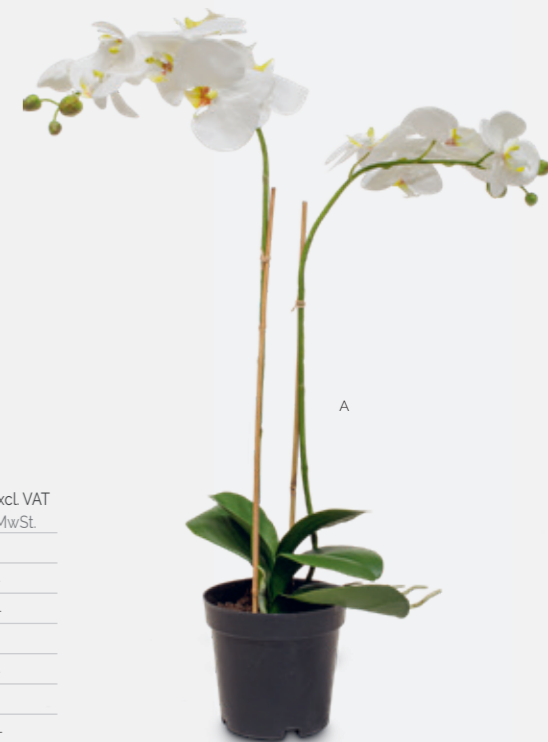

A



B



MAGNIFICO
PFLANZGEFÄSSE
#24182 #24183
on page · auf Seite 167

Name	☐	🗑️	🗑️	👁️	kg	#	sales price excl VAT UVP zzgl. MwSt.
Schmetterlingsorchidee - Phalaenopsis	71	14	13	16	1.7	A 24405	45.-
Medinilla	66	16	16	19	2.0	B 23842	159.-
Aloe	143	24	22.5	37	7.5	C 23834	299.-
Hortensie - Hydrangea, blau	55	13	12	134	1.5	D 20303	115.-
Hortensie - Hydrangea, blau	68	11	10	197	2.0	E 20301	149.-
Hortensie - Hydrangea, creme	55	13	12	134	1.5	F 20304	115.-
Hortensie - Hydrangea, creme	68	11	10	197	2.0	G 20302	149.-
Aloe	106	16	16	-	3.5	H 24406	179.-
Flieider - Syringa vulgaris	79	17	14	-	1.9	I 24393	145.-



D



B



180 cm

A

Name	□	☒	☒	☒	kg	#	UVP zzgl. MwSt. sales price excl. VAT
Farn	90	16	16	579	3.1	A 23570	179,-
Frauenhaarfarn <i>Adiantum capillus-veneris</i>	91	-	-	24	1.6	B 23583	179,-
Riesenfarn	185	24	22,5	341	6,5	C 23584	379,-
Goldtüpfelfarn - <i>Phebotidium aureum</i>	86	20,5	19,5	-	1,9	D 24394	139,-



A

GRACE PFLANZGEFÄSS
24179
on page · auf Seite 110

The
perfect look

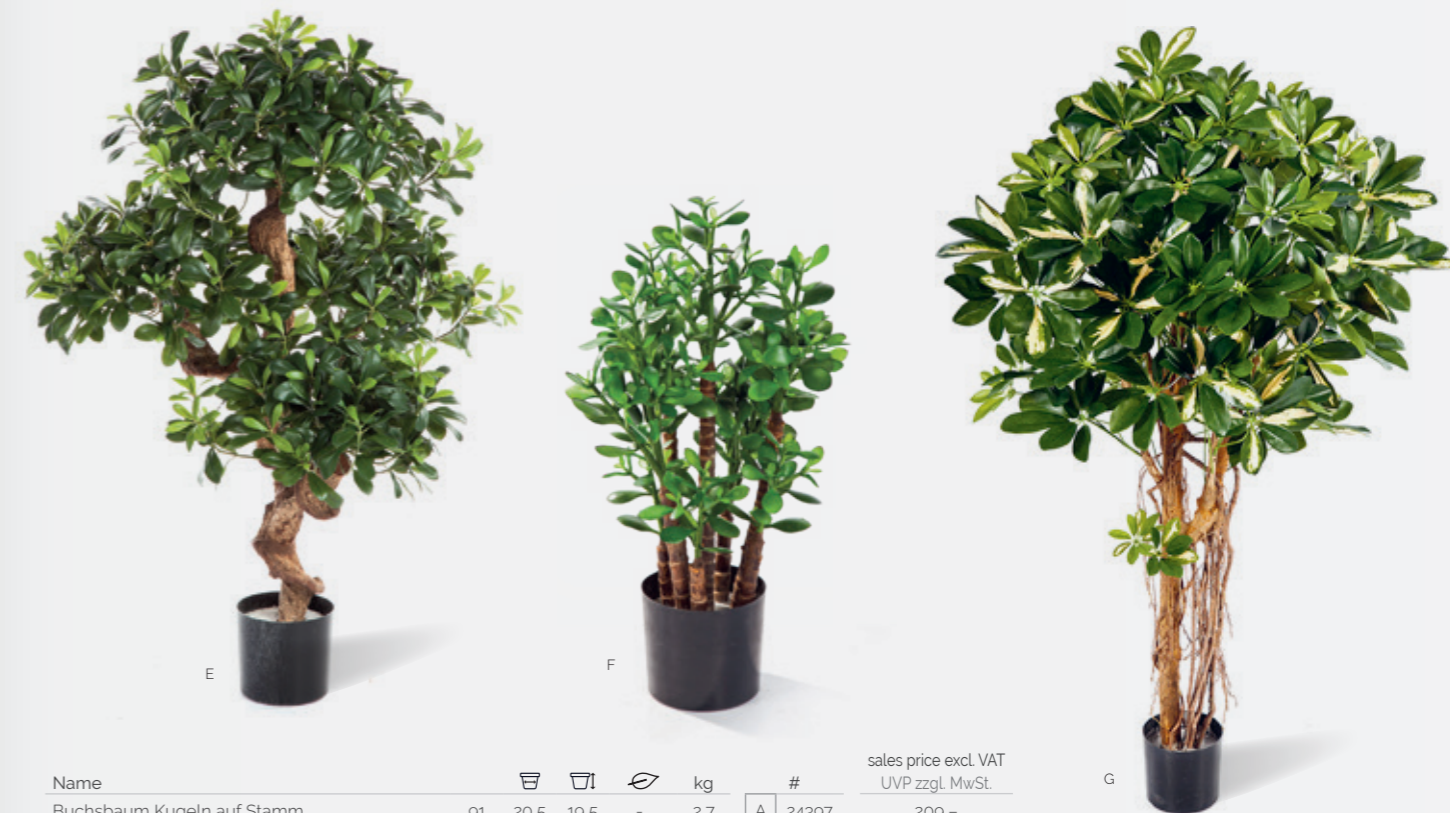

Name	🗑️	🗑️	👁️	kg	#	sales price excl. VAT UVP zzgl. MwSt.
Buchsbaum Kugeln auf Stamm	91	20,5	19,5	-	2,7	A 24397 209,-
Fiederaralie Polyscias	116	20,5	19,5	-	5,1	B 24395 189,-
Fiederaralie Polyscias	160	27	24	440	12,0	C 23572 349,-
Chinesischer Feigenbaum, Ficus Bonsai	107	24	22	1588	11,0	D 23573 359,-
Klebsame - Pittosporum	120	17	15	1599	6,6	E 20291 369,-
Geldbaum Crassula Ovata	60	16	15	480	4,3	F 20292 155,-
Strahlenaralie - Schefflera actinophylla	150	17	15	1222	5,7	G 20290 209,-
Ficus Panda Bonsai - Chinesischer Feigenbaum	45	12	12	576	3,5	H 21701 63,-



NEW!
NEU!

B



180 cm

A

UV-STABIL
UV-RESISTANT



NEW!
NEU!

C



CIGAR OXIDIZED
#24116
on page · auf Seite 131

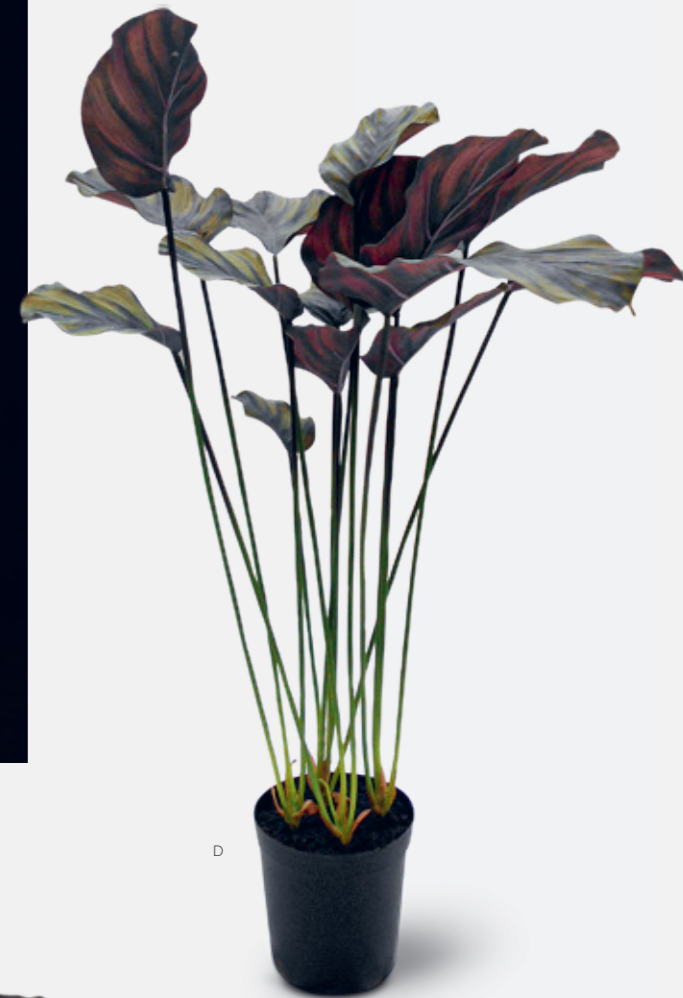

D



E



F

Name	☐	☒	☒	☒	kg	#	sales price excl. VAT UVP zzgl. MwSt.
Alocasia Calidora - Elefantenoehr	178	24	22.5	4	9.3	A 23578	325,-
NEU! Alocasia - Elefantenoehr	137	17	15	13	4	B 28429	115,-
NEU! Alocasia - Elefantenoehr ☀	137	16	13	18	2.4	C 28431	80,-
Calathea - Korbmarante	90	16	16	14	1.6	D 23585	79,-
Alocasia - Elefantenoehr	121	24	22.5	6	8.5	E 23839	299,-
Calathea - Korbmarante	64	14	13	13	1.7	F 24208	65,-



UV-STABIL
UV-RESISTANT

NEW!
NEU!



MAGNIFICO
PFLANZGEFÄSSE
#24181 #24204
#24182 #24183
on page auf Seite 167



Name	☐	☒	☒	☒	kg	#	sales price excl. VAT UVP zzgl. MwSt.
Ficus Elastica grün - Gummibaum	180	17	15	174	6.4	A 20287	269,-
Ficus Elastica grün - Gummibaum	90	13	13	135	3.0	B 20288	165,-
Ficus Elastica grün - Gummibaum	94	16	16	23	2.4	C 23579	169,-
NEU! Ficus Elastica grün - Gummibaum 	122	16	13	29	2.7	D 28425	98,-





ARTIFICIAL PLANTS

MUSCHEL PFLANZGEFÄSS
#23678
on page · auf Seite 173



Name	☐	☒	☒	☒	kg	#	sales price excl VAT UVP zzgl. MwSt.
Eucalyptus	90	17	14	-	1.0	A 24407	149,-
Glücksfeder - Zamiculcas	60	13	1	94	1.0	B 23589	79,-
Jadebaum Crassula Ovata	56	16	16	493	4.0	C 23835	269,-
NEU! Glücksfeder - Zamiculcas	90	22	19	154	10.9	D 28441	189,-

LOTS OF LEAFS

JEDE MENGE BLÄTTER



Name	□	☒	☒	☒	kg	#	sales price excl. VAT UVP zzgl. MwSt.
Raphis - Steckenpalme	150	17	15	545	5.7	A 20289	250,-
Longifolia Royal Natura	150	17	15	694	5.2	B 20296	259,-
Bamboo - Bambus	152	16	16	-	4.0	C 24398	229,-



POLYSTONE PLANT
COLUMN / PFLANZSÄULE
#23013 #23042 #23045
on page · auf Seite 27



Name	□	☒	☒	☒	kg	#	sales price excl. VAT UVP zzgl. MwSt.
Kobralilie - Darlingtonia	55	-	-	31	0.4	D 23587	69,-
Geweihfarn - Platycerium	55	24	14.2	-	1.7	E 24404	139,-
Sukkulente auf Stamm	53	19.5	20.5	57	3.6	F 23582	129,-
Bogenhanf - Sansevieria Cylindrica	100	22	18	24	3.2	G 20281	329,-



Name	☐	🗑️	🗑️	🍃	kg	#	sales price excl. VAT UVP zzgl. MwSt.
Kirschblütenbaum	213	20,5	19,5	1869	8,00	A 23580	505,-
Birkenbaum	193	20,5	19,5	-	6,5	B 24396	405,-
Do Dan Tree	175	20,5	19,5	-	2,7	C 24402	349,-



OLIVE TREES

GRACE PLANTERS
PFLANZGEFÄSS
#24176 #24177
on page · auf Seite 110



SUPER NATURAL

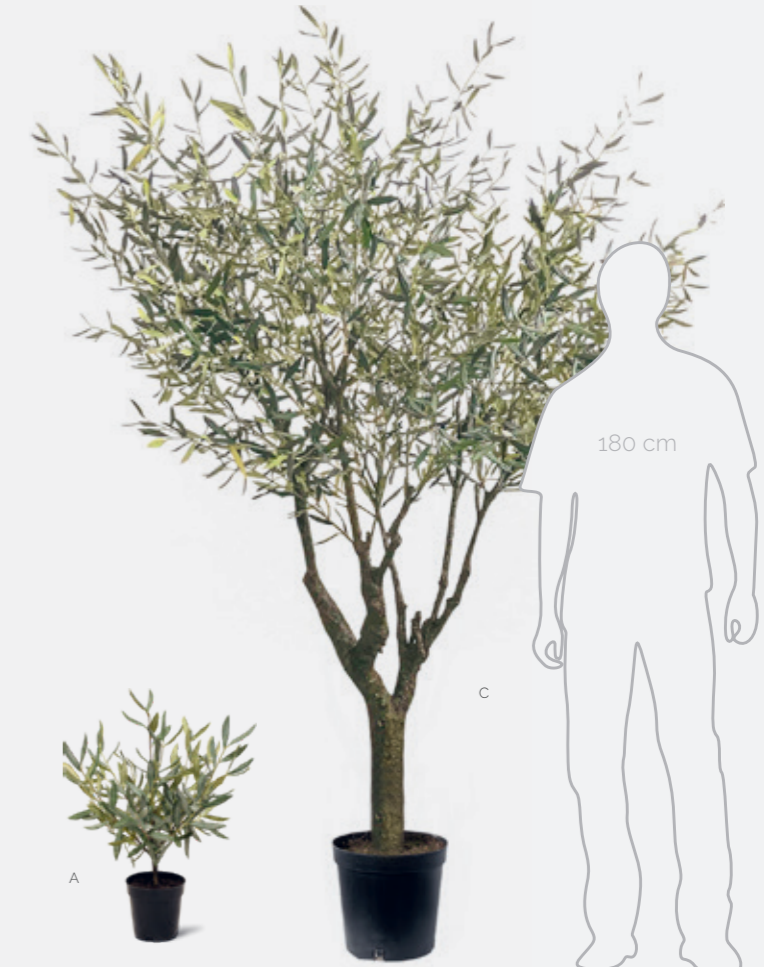

OLIVE TREES OLIVENBÄUME

Ø	□	☉	☼	☽	☿	kg	#	sales price excl. VAT UVP zzgl. MwSt.
39	51	14	13	-	1	1,0	A 24408	75,-
43	152	20,5	19,5	910	1	5,5	B 23575	349,-
72	244	30	27,5	3.282	1	30,0	C 23586	1.589,-

fleur ami® inliner:

Make planting easier.



fleur ami® inliner: Erleichtern das Bepflanzen.

PURCHASING NET PRICES / NETTO-EINKAUFSPREISE

#	ROUND / RUND			1 pc. basic price	2-9 pcs. save 15%	10-49 pcs. save 25%	> 50 pcs. save 35%	> 500 pcs. save even more
	Ø	□	🛒					
17893	15	15	11	2,20	1,87	1,65	1,43	BEST PRICE!
17894	21	16	16	2,80	2,38	2,10	1,82	BEST PRICE!
17895	25	15	18	3,30	2,81	2,48	2,15	BEST PRICE!
17896	30	22	21	4,70	4,00	3,53	3,06	BEST PRICE!
17897	35	25	24	4,95	4,21	3,71	3,22	BEST PRICE!
18603	40	30	28	5,95	5,06	4,46	3,87	BEST PRICE!
18604	45	35	32	7,10	6,04	5,33	4,62	on demand auf Anfrage
18605	50	38	36	8,90	7,57	6,68	5,79	BEST PRICE!
18606	55	40	43	11,50	9,78	8,63	7,48	BEST PRICE!
18607	60	45	44	12,50	10,63	9,38	8,13	BEST PRICE!
18608	65	48	53	13,80	11,73	10,35	8,97	BEST PRICE!
18609	70	45	54	19,50	16,58	14,63	12,68	BEST PRICE!
18610	80	60	70	25,00	21,25	18,75	16,25	BEST PRICE!



#	LEAN / SCHLANK			1 pc. basic price	2-9 pcs. save 15%	10-49 pcs. save 25%	> 50 pcs. save 35%	> 500 pcs. save even more
	Ø	□	🛒					
19799	25	21	16	3,50	2,98	2,63	2,28	BEST PRICE!
18614	35	40	26	8,20	6,97	6,15	5,33	on demand auf Anfrage
18615	40	45	30	10,50	8,93	7,88	6,83	BEST PRICE!

#	SQUARE / ECKIG			1 pc. basic price	2-9 pcs. save 15%	10-49 pcs. save 25%	> 50 pcs. save 35%	> 500 pcs. save even more
	□	□	🛒					
18611	32x32	30	27	5,90	5,02	4,43	3,84	BEST PRICE!
18612	38x38	30	35	7,60	6,46	5,70	4,94	on demand auf Anfrage
18613	48x48	35	42	11,50	9,78	8,63	7,48	BEST PRICE!

Prices on this page are **purchasing net prices**, not recommended sales prices as on the other pages.
 Preisangaben auf dieser Seite sind **Netto-Einkaufspreise**. Keine UVPs wie auf den übrigen Seiten.

The inliner are ideally suitable to line all kinds of pots, e.g. terracotta, ceramics, stainless steel or wood. They make pots leak proof and replace unappealing coasters. A time-consuming and unsafe sealing with silicone or pond liner is not necessary any more. The liner is made of soft and flexible plastic which can be cut or bent as needed. They also

prevent calcium deposits on planters surfaces and cause less evaporation and watering.

Perfekt geeignet zur Auskleidung von allen Pflanzgefäßen, z. B. Terrakotta, Keramik, Edelstahl, Holz. Sie machen jedes Gefäß auslaufsicher und ersetzen optisch unschöne

Untersetter. Dank der Pflanzeinsätze entfällt zeitaufwändiges und unsicheres Abdichten mit Teichfolie oder Silikon. Da sie aus weichem, biegbarem Kunststoff hergestellt sind, passen sie sich flexibel an das Gefäß an und lassen sich individuell beschneiden. Zudem werden Kalkablagerungen an den Gefäßwänden vermieden und die Verdunstung reduziert.

INLINER



Also fits in rectangular planters
Passen auch in eckige Pflanzgefäße



Adjust the height
Höhe anpassen



Perfect fitting
Passt perfekt

Perfect to smoothly adjust the plantation depth of columns or tall planters
Optimal zum Ausgleich von Pflanztiefen bei Säulen oder hohen Gefäßen

fleur ami® inliner advantages

- Makes all pots leak proof
- Can be cut or bent as needed
- Even adapts to square shapes
- Smoothly adjusts plantation depth of planters
- Prevents calcium deposits
- Causes less evaporation and watering



The display has a large sign showing the application range and advantages and guarantees an optimal product presentation. Thanks to its modular construction it offers versatile display possibilities. The display is suitable for indoor and outdoor use and saves valuable space in the sales area. Because it is preassembled on euro pallets, the display is easy to handle with a forklift or pallet jack. It also includes a brochure rack and space for price tags on each bracket.

Der Verkaufsständer ist ausgestattet mit einem großflächigen Schild, auf dem Anwendungsbereich und Vorteile der Pflanzeinsätze aufgezeigt werden - damit ist eine optimale Produktpräsentation gewährleistet. Durch den modularen Aufbau ist er individuell bestückbar. Der Verkaufsständer ist sowohl im Innen- als auch Außenbereich einsetzbar und spart wertvollen Raum im Verkaufsbereich. Zudem ist er auf Europaletten vormontiert und daher leicht mit Gabelstapler oder Hubwagen zu transportieren. Inklusive Prospekthalter und Vorrichtung für Preisschilder an jedem Korb.

**FREE/
GRATIS
DISPLAY**

for orders of
300 pieces of inliners/
bei Abnahme von
300 Stück

INLINER (VERKAUFSTÄNDER · DISPLAY)		sales price excl. VAT UVP zzgl. MwSt.
kg	#	
26	16018	398,-



SHELL
#19496 #19498 #20374
on page · auf Seite 169

DESIGNED
BY NATURE.

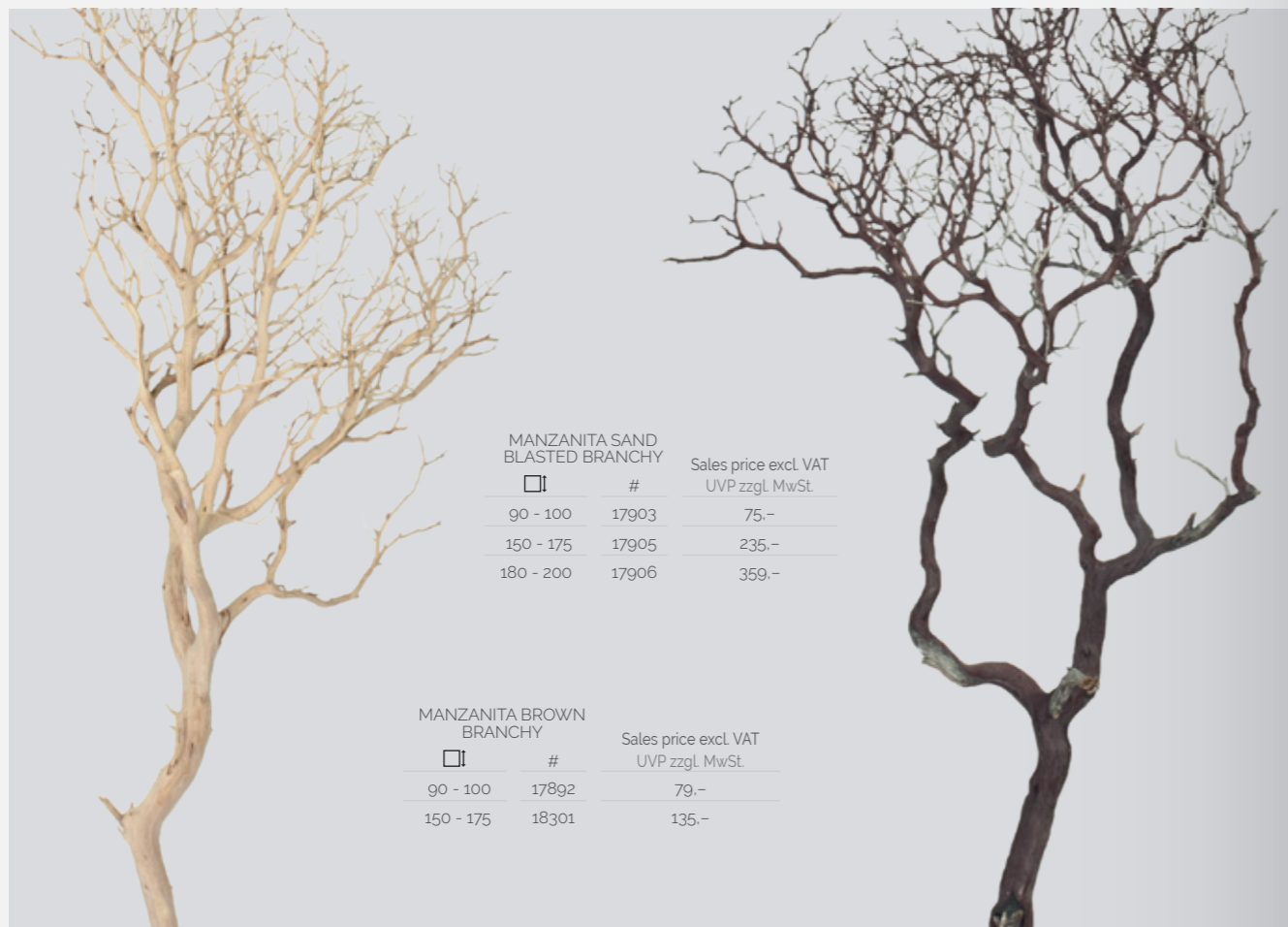

MANZANITA SAND BLASTED BRANCHY		Sales price excl. VAT UVP zzgl. MwSt.	
□	#		
90 - 100	17903	75,-	
150 - 175	17905	235,-	
180 - 200	17906	359,-	

MANZANITA BROWN BRANCHY		Sales price excl. VAT UVP zzgl. MwSt.	
□	#		
90 - 100	17892	79,-	
150 - 175	18301	135,-	



VERY
DECORATIVE.

NATURAL PRODUCT!
Each item is unique.

NATURPRODUKT!
Jeder Artikel ein Unikat.

GHOSTWOOD SAND BLASTED BRANCHY		Sales price excl. VAT UVP zzgl. MwSt.	
□	#		
90 - 100	17912	99,-	
120 - 140	17913	165,-	
150 - 175	17914	235,-	



More information online!

Small things for the perfect look

Kleinigkeiten für den perfekten Look.

The styrofoam inserts smoothly adjust the plantation depth - especially for tall planters - and save time and material.

Die Styroporeinsätze sind ideal geeignet zum Anpassen der Pflanztiefe - besonders bei hohen Gefäßen - und sparen Zeit und Material.

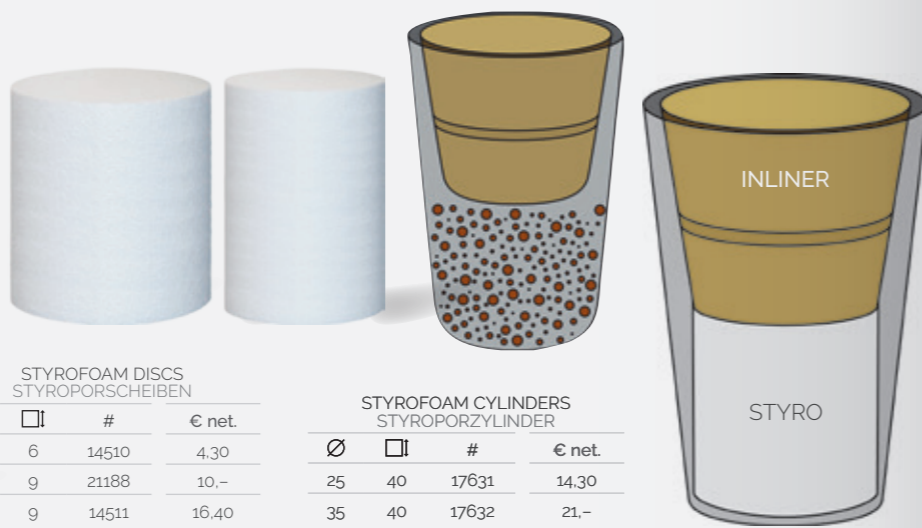

ROCKS



Real rocks, slate and glass from nature - every piece is unique. Illustrations exemplary. Packed in transparent bags.
Echte Steine, Schiefer und Glas aus der Natur - jedes Stück ein Unikat. Abbildungen beispielhaft. In transparenten Beuteln.



SLATE · SCHIEFER

Ø	kg	slate schiefer	sales price excl. VAT UVP zzgl. MwSt.
2-4	5	22279	15,-
2-4	25	22277	65,-
4-7	5	22280	15,-
4-7	25	22278	65,-



COCONUT SHELL · KOKOSSCHALE

Ø	kg	black schwarz	sales price excl. VAT UVP zzgl. MwSt.
0,3 - 0,4	5	28689	49,-



RIVER PEBBLES · FLUSSKIESEL

Ø	kg	white weiß	sales price excl. VAT UVP zzgl. MwSt.
2-4	5	19847	25,-
2-4	20	19850	85,-



NATURAL STONES · NATURSTEINE

Ø	kg	grey hellgrau	sales price excl. VAT UVP zzgl. MwSt.
16-22	5	28690	25,-
16-22	25	28691	105,-



RIVER PEBBLES · FLUSSKIESEL

Ø	kg	black schwarz	sales price excl. VAT UVP zzgl. MwSt.
2-4	5	19849	25,-
2-4	20	19852	85,-

CLAY · TON

The clay convinces with a very good water retention and capillarity. It has a stable structure, is purely mineral and therefore supports the gas exchange from substrate to the root perfectly. The clay is ideal for hydroculture and roof planting, frost and weather resistant and does not rot or compress. Further grain sizes and packing sizes are available on request (e. g. bags, big bags or bulk). The minimum order unit for expanded clay is 1 pallet ex works and

1 bag (Lamstedt-Ton only) ex warehouse Tönisvorst. Please ask our sales team for pricing.
Der Ton überzeugt mit einer sehr guten Wasseraufnahmefähigkeit und -führung. Zudem ist er strukturstabil, rein mineralisch und fördert daher den Gasaustausch von Substrat und Wurzel. Dank seines günstigen Dränierverhaltens beugt er Wurzelfäulnis vor und ist ideal für Hydrokulturen und Dach-

begrünungen. Darüber hinaus ist der Ton frost- und witterungsbeständig und verrottet und verdichtet nicht. Weitere Körnungen und Gebindegrößen sind auf Anfrage erhältlich (z. B. auch Big Bags oder lose Ware). Blähton ist palettenweise ab Werk erhältlich. Lamstedt-Ton alternativ auch sackweise ab Lager Tönisvorst. Bitte erfragen Sie die jeweiligen Preise bei unserem Vertriebsteam.

BIG BAG Gebinde auf Anfrage/on request

LAMSTEDT-TON®

Ø mm	ltr	#	sales price excl. VAT UVP zzgl. MwSt.
8 - 16	50	36 14520	37,-





Healthy growth

Gesundes Wachstum.

Especially invented for hydroponic use, the long term fertiliser is based on ion exchange resin and provides plants with essential nutrients and trace elements. It seeps directly to the roots and the time release components ensure effectiveness for 4 to 6 months. Thanks to dry resin the volume remains constant - therefore there is no volume loss during storage. The long term fertiliser is available in various packaging sizes; from small consumer packs up to bulks for professionals. The labels are multilingual and also available with your own private label upon request.

Der speziell für Hydrokulturen entwickelte Ionenaustauscher versorgt die Pflanzen mit wichtigen Nährstoffen und Spurenelementen. Er rieselt direkt bis zur Wurzel und wirkt dort gleichmäßig über 4-6 Monate. Durch trockene Harzkügelchen hält er sein Volumen konstant und schrumpft auch bei längerer Lagerung nicht. Von Portionsverpackungen für Endverbraucher bis zu Großbinden für Profis - der Langzeitdünger ist in diversen Verpackungsgrößen lieferbar. Die Etikettierung ist mehrsprachig und auf Anfrage auch mit eigenem Etikett möglich.

HM10™ LONG TERM FERTILIZER · LANGZEITDÜNGER

Type	#	€ net.
10 ltr	10247	295,-
25 ltr	10249	695,-



LEAFSHINE BLATTGLANZ

LEAFSHINE includes natural oils for a healthy shine and makes sure that water and calcium stains disappear for good. Besides plants leaves longer remain free of dust. LEAFSHINE also helps to protect against insects and prevents excessive evaporation. The ready-to-use solution is environmentally safe propellant (CFC free). For canisters a hand sprayer with 15 m hose length is available.

LEAFSHINE enthält pflanzliche Öle für einen gesunden, natürlichen Glanz und verhindert dauerhaft eine Bildung von Wasser- und Kalkflecken. Zudem sorgt es dafür, dass die Blätter lange Zeit staubfrei bleiben und schützt die Pflanze vor übermäßiger Verdunstung. Das verwendete Treibmittel ist umweltfreundlich, da FCKW-frei und das LEAFSHINE ist sprühfertig und unverdünnt anwendbar. Für Kanisterware ist ein Handsprüher mit einem 1,5 m langem Schlauch optional erhältlich.



FLEUR AMI LEAFSHINE · FLEUR AMI BLATTGLANZ

Type	☞	☞	#	Sprachen · Languages	€ net.
750 ml	12	960	10104	DE, NL, UK, FR, ES, IT, Arabic	13,-

LEAFSHINE is also available in various large containers.

LEAFSHINE ist auch in verschiedenen Großbinden erhältlich.



FLEUR AMI LEAFSHINE · BLATTGLANZ

Type	#	Sprachen · Languages	€ net.
5 ltr	10107	DE, UK, FR, ES	49,-
30 ltr	10108	DE, UK, FR, ES	275,-
200 ltr	10102	DE, UK, FR, ES	1999,-





SPART ZEIT UND AUFWAND

Das SERVICE CAR ist besonders leicht und robust dank des innovativen Fiberglastanks. Für mehr Wendigkeit und Übersichtlichkeit sorgt das Gestell mit seinen vergleichsweise kleinen Abmessungen. Für ein einfaches Verladen und Transportieren ist das SERVICE CAR mit kleinen Rollen am Griff ausgestattet. Leise, kugelgelagerte Rollen mit innenliegenden Radmuttern (damit Sie schadensfrei durch die Räume Ihres Kunden kommen) garantieren ein dezentes und geräuscharmes Arbeiten vor Ort. Dazu kommen weitere tolle Vorteile: Das SERVICE CAR wird in drei verschiedenen Größen angeboten (bis zu 140 Liter Füllvolumen) und es garantiert bis zu 80% Zeitersparnis, da es automatisch ohne Aufsicht befüllt werden kann und wartungsfrei ist, da es ohne Strom, Motor und Kabel auskommt. Wahlweise werden Geka- oder Gardena-Anschlüsse mitgeliefert. So sorgt das SERVICE CAR für einen professionellen Auftritt beim Kunden und ein körperschonendes, bequemes Arbeiten. Einfach, sicher, sauber!



More information online!

THE ULTIMATE TIME SAVER

Thanks to its innovative fibreglass tank the SERVICE CAR is extremely light and robust and its smaller frame guarantees better handling. For easy loading and transport the handles have small wheels. For a damage-free plant maintenance at your customer's premises, the SERVICE CAR has silent, ball bearing wheels with short wheel nuts. It is available in three different sizes up to 140 litres of water volume. The SERVICE CAR enables up to 80% time savings, because it automatically fills without supervision and is maintenance-free, because it works without any electricity, cable or motor. Furthermore you can choose between Geka or Gardena

connections. The SERVICE CAR provides a professional appearance and promotes a comfortable and healthy working environment. Easy, safe and clean!

SERVICE CAR			
Type	ltr	kg	#
GARDENA Mod. L	*70	34	20683
GARDENA Mod. XL	*100	47	20684
GARDENA Mod. XXL	*140	53	20685
GEKA Mod. L	*70	34	20686
GEKA Mod. XL	*100	47	20687
GEKA Mod. XXL	*140	53	20688

*depending on water pressure / abhängig vom Wasserdruck

PRICES · PREISE

Prices and delivery time on demand
Preise und Lieferzeiten auf Anfrage

ACCESSORIES · SERVICE CAR ZUBEHÖR

Type	#
Utility bag · Zubehörtasche	14404
GARDENA spray gun · Spritzpistole	15617
GARDENA watering lance · Gießlanze	15616
GARDENA fertiliser injector · Dünginjektor	14414
GEKA fertiliser injector · Dünginjektor	15967
GEKA watering lance · Gießlanze	15968

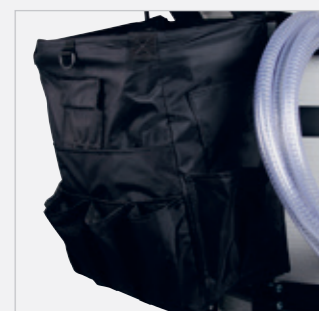

Utility bag with waterproof plastic container
Zubehörtasche mit wasserdichtem Kunststoffbehälter



Water spray gun
Spritzpistole



Watering lance
Gießlanze



Fertiliser injector
Dünginjektor mit Zubehör

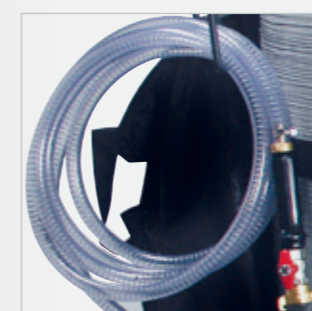

Sturdy PVC fabric hose (5 m)
Robuster PVC Spiralschlauch (5 m)



Light coloured, silent wheels
Helle, leise Rollen

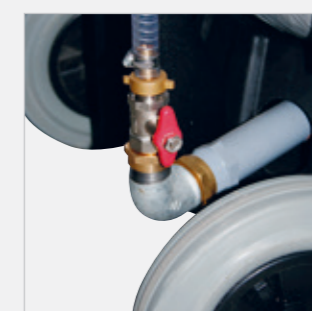

Emergency stop valve
Sicherheits-Absperrhahn



Parking brake
Feststellbremse



GEKA connector
GEKA Adapter

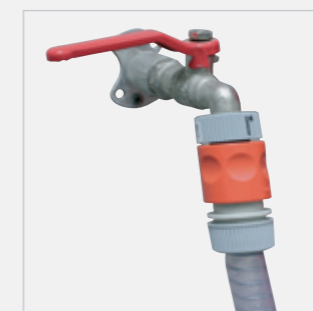

GARDENA connector
GARDENA Adapter

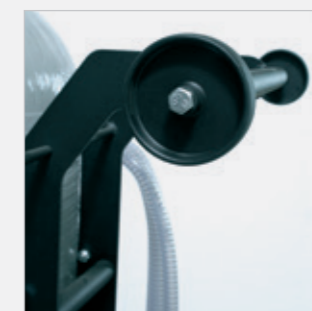

Handle with small loading wheels
Griff mit kleinen Verladerrollen



Easy loading by one person possible
Einladen durch eine Person möglich

ALL INCLUSIVE SETS:

Planter & artificial plant *Pflanzgefäß & Kunstpflanze*

ECONOMY

- DESIGN
- WOW-EFFECT
- PREMIUM PLANTS
- BUDGET



- ✓ Ready assembled! *Fertig zusammengestellt!*
- ✓ Quick & easy to order! *Schnell & einfach bestellt!*



MORE: www.fleur-ami.com/economy/

BUSINESS

BEST BUY

- DESIGN
- WOW-EFFECT
- PREMIUM PLANTS
- BUDGET



MORE: www.fleur-ami.com/business/

PREMIUM

- DESIGN
- WOW-EFFECT
- PREMIUM PLANTS
- BUDGET



MORE: www.fleur-ami.com/premium/



fleur ami® GmbH

Höhenhöfe 6 · 47918 Tönisvorst · Germany
T+49 (0) 2151/93521-0 · info@fleur-ami.com

Showroom, office and warehouse:

www.fleur-ami.com

